

COLOR READER

CR-20

Instruction Manual

 Please read before using the instrument.



KONICA MINOLTA

■ Safety Symbols

The following symbols are used in this manual and on the instrument to prevent accidents that may occur as result of incorrect use of the instrument.



Denotes a sentence regarding a safety warning or note.
Read the sentence carefully to ensure safe and correct use.



Denotes a prohibited operation.
The operation must never be performed.



Denotes an instruction.
The instruction must be strictly adhered to.



Denotes a prohibited operation.
Never disassemble the instrument.



Denotes an instruction.
Always disconnect the AC adapter from the AC outlet.



This symbol indicates alternating current (AC).



This symbol indicates direct current (DC).



This symbol indicates class II protection against electric shock.

Notes on this Manual

- Copying or reproduction of all or part of the contents of this manual without the permission of KONICA MINOLTA is strictly prohibited.
- The contents of this manual are subject to change without prior notice.
- Every effort has been made in the preparation of this manual to ensure the accuracy of its contents. However, should you have any questions or find any errors, please contact a KONICA MINOLTA-authorized service facility.
- KONICA MINOLTA will not accept any responsibility for accidents that arise from the use of the instrument or products used other than as directed in this manual.

Official names for applications and the like used in this manual













(Wording used in text)	(Official name)
Windows, Windows 7	Microsoft® Windows® 7 Professional Operation System
Windows, Windows 8	Microsoft® Windows® 8 Pro Operating System
Windows, Windows 8.1	Microsoft® Windows® 8.1 Pro Operating System





Trademarks







- Microsoft, Windows, Windows 7, Windows 8, and Windows 8.1 are registered trademarks of Microsoft Corporation in the United States and/or other countries. Other company and product names included in this manual are trademarks or registered trademarks of their respective companies.

Safety Precautions

To ensure correct use of this instrument, read the following points carefully and adhere to them.
After you have read this manual, keep it in a safe place where it can be referred to anytime a question arises.

	WARNING (Failure to adhere to the following points may result in death or serious injury.)
	Do not use the instrument in places where flammable or combustible gases (gasoline, etc.) are present. Doing so may cause a fire.
	Always use KONICA MINOLTA's optional accessory AC adapter (AC-A308) or USB bus power AC adapter (AC-A305J,K,L,M) connected to an AC outlet of the rated voltage and frequency 100-240 VAC (50/60 Hz). If an AC adapter other than those specified by KONICA MINOLTA is used, or if the adapter is connected to an unsupported voltage, it may result in damage to the adapter, fire, or electric shock.
	If the instrument will not be used for a long time, disconnect the AC adapter power plug from the AC outlet. Accumulated dirt or water on the prongs of the AC adapter's plug may cause a fire and should be removed. Clean off any dirt or water on the prongs of the AC adapter's plug before use.
	Do not insert or disconnect the AC adapter with wet hands. Doing so may cause electric shock.
	Do not disassemble or modify the instrument or the AC adapter. Doing so may cause a fire or electric shock.
	The instrument should not be operated if it is or the AC adapter is damaged, or if smoke or odd smells occur. Doing so may cause a fire. In such situations, turn the power OFF immediately, disconnect the AC adapter power plug from the AC outlet (or remove the batteries if using battery power) and contact the nearest KONICA MINOLTA-authorized service facility.
	Take special care not to allow liquid or metal objects to enter the instrument. Doing so may cause a fire. Should liquid or metal objects enter the instrument, turn the power OFF immediately, disconnect the AC adapter power plug from the AC outlet (or remove the batteries if using battery power) and contact the nearest KONICA MINOLTA-authorized service facility.
	Do not forcibly bend, twist or pull the power cord. Do not place heavy objects on, or damage or modify the power cord. Doing so may damage the power cord and cause fire or electric shock.
	Always disconnect the power cord by holding the power plug. Pulling the power cord itself may damage it and cause fire or electric shock.
	Firmly push the AC adapter power plug completely into the outlet. If the power plug is not pushed completely in, it may cause a fire or electric shock.
	Do not dispose of the batteries in a fire or charge, short-circuit, heat, or disassemble the batteries. Doing so may cause the batteries to rupture or leak, which could result in fire or injury.

	In the event that a battery leaks and the fluid comes into contact with your eye, do not rub your eye and wash it with clean water, and then immediately consult a doctor. If the leaked fluid comes into contact with skin or clothing, immediately rinse with water. In addition, stop using the instrument if one of its batteries has leaked.
	Use a dedicated charger (of the specified type, model, etc.) to charge nickel-metal hydride batteries. If charging conditions or a charger different from that specified is used for charging, the battery may leak, overheat, or catch fire.
	Correctly dispose of batteries used in the instrument. Batteries incorrectly disposed of may short-circuit, overheat, and catch fire. This may lead to fire, injury, or burns. Battery disposal methods vary depending on each municipality. Adhere to municipal instructions when disposing of batteries, or give the batteries to your contracted waste disposal contractor.
	Do not touch the batteries with wet hands. Doing so may result in electric shock or a malfunction.
	Do not look directly at the lamp. The lamp is extremely bright and emits ultraviolet rays. Doing so may injure the eyes.

	CAUTION (Failure to adhere to the following points may result in injury or damage to the instrument or other property.)
	When using the AC adapter, provide an environment such that there is an outlet near the instrument and the power plug of the AC adapter can be easily plugged or unplugged.
	Take care not to pinch yourself on the areas of the instrument that open and close. Doing so may result in injury.
	Do not use any batteries other than those specified for the instrument. Do not use a new battery and an old battery or batteries of different types together. When loading the batteries into the instrument, ensure they are oriented according to the polarity indication (positive + and negative -) on the instrument. Otherwise, the batteries may break or leak, resulting in a fire or injury, or contamination of the area.
	Do not use the instrument if the sample surface aperture (measurement area) is in the line of sight. Doing so may result in injury to the eye.
	Take sufficient care when handling the target mask. The sample surface aperture glass may become cracked, resulting in injury.
	When cleaning the instrument, unplug the AC adapter power plug from the outlet. Failure to do so may cause electric shock.

Introduction

Thank you for purchasing this KONICA MINOLTA instrument.

This instrument is a lightweight, compact colorimeter for reflecting an object's color. It was developed to provide colorimetry in a variety of industrial fields. In addition, when used with the included PC application, data saved in the instrument can be displayed in a list and saved to the PC.

Packing materials of the product

Be sure to keep all packing materials used for shipping the product (cardboard box, cushioning material, plastic bags, etc.).

This instrument is a precision measuring instrument. When transporting the instrument to a service facility for maintenance or for other reasons, be sure to use the packing materials to minimize shock or vibration. If the packing materials are lost or damaged, contact a KONICA MINOLTA-authorized service facility.

Notes on Use

Always use the instrument correctly. If the instrument is used in a manner not described in this instruction manual, it may cause injury, electrocution, or damage to the instrument itself.

Operating Environment

Use the instrument at an ambient temperature between 0°C and 40°C and a relative humidity of 85% or less (at 35°C) with no condensation. Be sure to use the instrument within this range.

- If the operating humidity range is exceeded, errors may occur for measurements of dark colors. Do not use it in areas of rapid temperature changes.
- Do not leave the instrument in direct sunlight or near heat sources such as a stove. Doing so may cause the internal temperature of the instrument to become much higher than the ambient temperature.
- Do not use the instrument in areas where dust, cigarette smoke, or chemical gases are present. Doing so may cause deterioration in performance or the instrument may malfunction.
- Do not use the instrument near equipment that produces a strong magnetic field (such as speakers).
- The instrument is a pollution level 2 product (equipment that may cause temporary electrical hazards due to contamination or condensation or products that are used in such an environment).
- Do not use the instrument at altitudes higher than 2,000 m.
- The optional AC adapter has been designed exclusively for indoor use. Do not short-circuit the output plug. The AC adapter should never be used outdoors because rain or other factors may result in a risk of electric shock or fire.
- Mount the instrument securely on the tripod to prevent it falling over or dropping. Otherwise, injury or the damage of the instrument or surrounding objects may result.

Measurement

- When not using the instrument for a long period of time, blow off dirt or dust on the receptor window with a blower before use.
- Take care to prevent dust and the like from entering the opening on the instrument when using it upside down.

Target Mask

- Do not touch the inside of the target mask, allow the mask to get dirty, or scratch the mask.

White Calibration Cap

- Do not allow the white calibration area to become scratched or dirty, such as from fingerprints.

Power Source

- When the instrument is not being used, turn the power OFF.
- This instrument can be used with AA batteries (alkaline or nickel-metal hydride rechargeable batteries), with the AC adapter (AC-A308), or the USB bus power AC adapter (AC-A305J,K,L,M). These adapters cannot be used for charging the nickel-metal hydride rechargeable batteries in the instrument.
- Be sure to use only the AC adapter specified by KONICA MINOLTA and connect it to a 100-240 VAC (50/60 Hz) AC outlet. Use an AC power supply of the rated supply voltage (within $\pm 10\%$).
- Do not connect the AC adapter to an overloaded electrical circuit. In addition, do not wrap or cover the AC adapter with cloth or other material while in use. Doing so may cause an electric shock or fire.

System

- Do not subject the instrument to strong impacts or vibrations. Doing so may cause deterioration in performance or the instrument may malfunction.
- Do not subject the sample surface aperture of the instrument to impact. When not in use, make sure to attach the cap.
- The instrument may cause interference if used near televisions, radios, etc.
- When the instrument is exposed to strong external static electricity, the LCD may go blank or the measurement result may not be displayed properly. If the instrument is communicating with an external device, the communication may also be interrupted. In such cases, turn the power OFF and then turn it ON again. If black smudges appear on the LCD, wait until they disappear naturally.
- When turning the power OFF and then ON again, wait several seconds after turning the power OFF.

Battery Backup

- The backup batteries are automatically charged when the instrument is operated, and at full charge the memory content will be saved for 34 months under normal conditions. In addition, the backup batteries will be fully charged after 27 hours if the instrument is powered using batteries, the AC adapter, or USB bus power, regardless of whether the instrument is turned ON/OFF. There is no need to worry about overcharging.

Introduction (Cont.)

- Even if the backup batteries are depleted, the various settings and saved data will be kept in the instrument. However, periodic backup of important data to another storage medium using the included software is recommended.

Notes

- Do not attempt to replace the backup battery by yourself. Contact a KONICA MINOLTA-authorized service facility instead.

Notes on Storage

- The instrument should be stored at a temperature between -20°C and 45°C with a relative humidity of 85% or less (at 35°C) and no condensation. Do not store the instrument in areas subject to high temperatures, high humidity, or sudden changes in temperature, or in areas where condensation may occur, as these circumstances may cause a malfunction. We recommended you store the instrument with a drying agent at a temperature around 20°C.
- Do not leave the instrument inside a car such as in the cabin or the trunk. Otherwise, the temperature and/or humidity may exceed the allowable range for storage during midsummer or midwinter, resulting in a malfunction.
- Keep the packing materials used for shipment and use them to transport the instrument. This material will protect the instrument from sudden changes in temperature and from vibration and shock.
- Do not store the instrument in areas where dust, cigarette smoke, or chemical gases are present. Doing so may cause deterioration in performance or the instrument may malfunction.
- Be sure to keep all packing materials (cardboard box, cushioning material, plastic bags, etc.). They can be used to protect the instrument during transportation to the service facility for maintenance (re-calibration, etc.).
- If there is dust inside the sample surface aperture, measurement will not be performed correctly. When the instrument is not in use, make sure to attach the protective cap before storing to prevent dust and the like from entering the integrating sphere through the sample surface aperture.
- Be sure to store the target mask where it will be protected from becoming scratched or exposed to dust.
- If the instrument will not be used for 2 weeks or more, remove the batteries. Otherwise, the batteries may leak and damage the instrument.
- When the white calibration cap is not being used, put on the dedicated lid, and store it in a location protected from external light.

Notes on Cleaning

- When the instrument is dirty, wipe it with a soft, clean dry cloth. Never use solvents such as thinner or benzene.
- If there is dust or dirt on the receptor window, use a blower to blow it off or gently wipe it with a soft, clean dry cloth. Never use solvents such as thinner or benzene. If you are unable to remove dirt from the instrument or if the instrument becomes scratched, contact a KONICA MINOLTA-authorized service facility.
- Contact a KONICA MINOLTA-authorized service facility if the inside of the target mask or the inside of the integrating sphere becomes dirty.
- Should the instrument break down, do not try to disassemble or repair it by yourself. Contact a KONICA MINOLTA-authorized service facility.

Disposal Method

- When disposing of the batteries used in this instrument, use tape or some other material to electrically insulate the contacts. Contact with other metals may cause the batteries to overheat, rupture, or catch fire.
- Make sure that the instrument, its accessories (and used batteries), and the packing materials are either disposed of or recycled correctly in accordance with local laws and regulations.

Table of Contents

Safety Precautions	3	Chapter 3 PC Application	37
Introduction	4	Connecting to a PC	38
Notes on Use	4	Connecting to/Disconnecting from a PC	38
Notes on Storage	5	When First Connecting to the PC	39
Notes on Cleaning	5	Launching the PC Application	41
Disposal Method	5	Exiting the PC Application	41
Table of Contents	6	Points to Remember	42
Chapter 1 Before Using the Instrument	7	PC Application Settings	42
Checking the Included Accessories	8	PC Application Operation Screen	43
Standard Accessories	8	Instrument Info Display	46
Optional Accessories	9	Checking CR-20 Information	46
System Diagram	10	Instrument Settings	47
Names and Functions of Parts	11	Mask Setting	47
Handling the Instrument	12	Environment Settings (Changing Instrument Settings)	48
Attaching the Wrist Strap	12	Save Meas. Data	48
Inserting Batteries	13	Language	49
Powering from a PC	13	Auto Off	50
Connecting an AC Adapter	14	Date/Time	51
Attaching/Removing the Target Mask	15	PC Application (Measurement)	55
White Calibration Cap CR-A86	16	White Calibration	56
Cleaning the Components	17	Measurement	57
Turning the Power ON/OFF	18	Measurement	57
Display Language (When first turning the CR-20 ON)	19	Avg. Meas.	58
Battery Warnings	20	Save Meas. Data	59
Points to Remember	21	Measurement Result Display	60
Instrument Operation/Display	21	Importing Measurement Data	60
Instrument Info Display	23	Measurement Data Operations	61
Checking CR-20 Information	23	Save to PC (Obtain Measurement Data Saved in Instrument)	61
Chapter 2 Measurement	24	Clear Inst. Data	62
Flow of Measurement	25	Copy to Clipboard	63
Part 1. Measurement	26	Chapter 4 Other Functions	64
White Calibration	27	Connecting a Printer	65
Measurement	28	Printing Measurement Data	66
Avg. Meas.	29	Disconnecting from the Printer	66
Switching Measurement Result Displays	30	Chapter 5 Troubleshooting	67
Part 2. Instrument Settings	31	Memory Errors	68
Various Settings/Instrument Settings	32	When not performing recovery	68
Mask Setting	32	Performing Recovery	68
Various Settings/Other Settings	33	Error Messages	70
Language	33	Checking for Malfunction	71
Auto Off	34	Chapter 6 Appendix	72
Date and Time Setting	35	Dimensions	73
Measurement Data Operations	36	Main Specifications	74
Browse Data	36	PC System Requirements	74

Chapter 1

Before Using the Instrument

Checking the Included Accessories

This instrument can be used with the following standard accessories and optional accessories.

Standard Accessories

Verify that all of the following items are included.

■ Target Mask

Approx. \varnothing 8 mm, w/ protective aperture glass plate

The target mask is used for aiming and correctly measuring a measurement location.

Memo The color reader comes shipped from the factory with the target mask already attached.

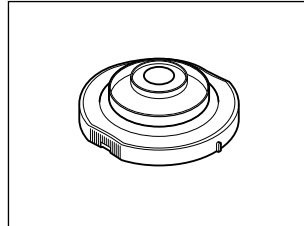

■ White Calibration Cap CR-A86

Memo • When not in use, put on the dedicated lid and store the cap.

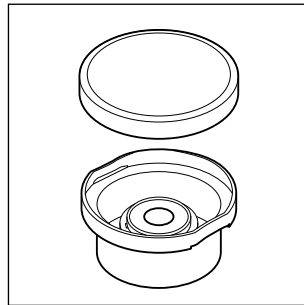

■ USB Cable IF-A25

Used to connect the instrument to a PC.

When using the USB bus power AC adapter, power will be supplied through the USB cable (IF-AF25).

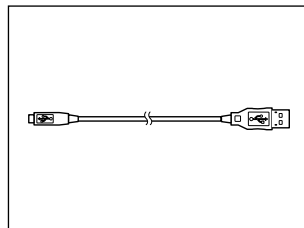

■ Wrist Strap CR-A73

Used to prevent users inadvertently dropping the instrument.

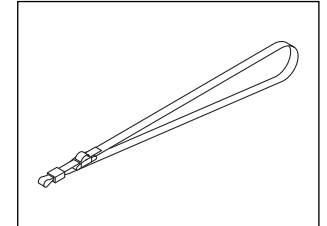

■ Protective Cap CR-A93

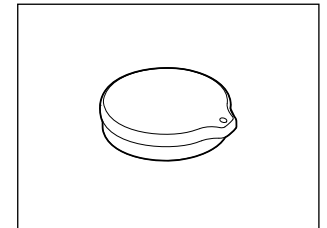

■ Soft Case CR-A94

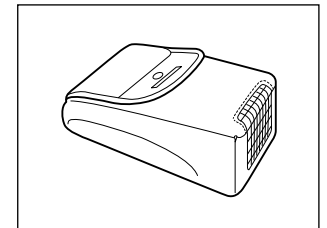

■ 4 AA Batteries

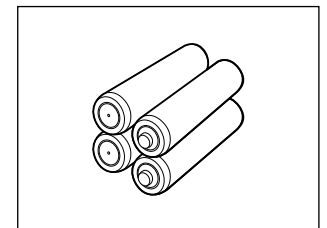

Checking the Included Accessories (Cont.)

Optional Accessories

Purchase the following separately sold accessories as necessary.

■ AC Adapter AC-A308

The adapter is used to supply power from the AC power supply to the instrument.

Input: 100-240 V \sim 50/60 Hz 25-38 VA

Output: 8 V \equiv 1.5 A

Plug design: \oplus \ominus \ominus

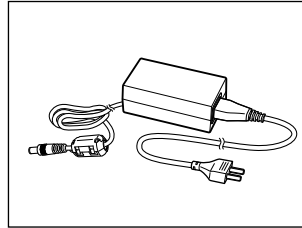

■ USB Bus Power AC Adapter

AC-A305J,K,L,M (UBX305)

AC-A305J

(North and South America, Taiwan and Japan)

AC-A305K

(China)

AC-A305L

(Korea)

AC-A305M

(Europe and Singapore)

*Form differs according to region.

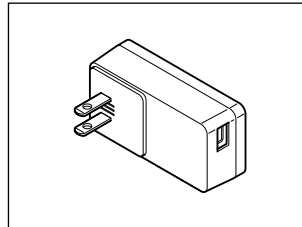

■ Hard Case CR-A90

This case can be used to store the instrument together with its accessories.

* Do not use the case for transporting or shipping.

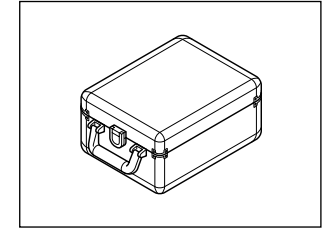

■ Protective Cover CR-A91

This set prevents foreign contaminants from getting inside the instrument when used in locations prone to dust.

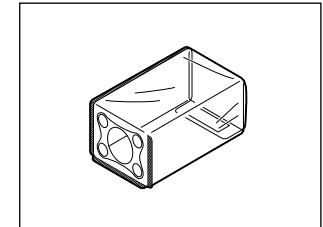

System Diagram

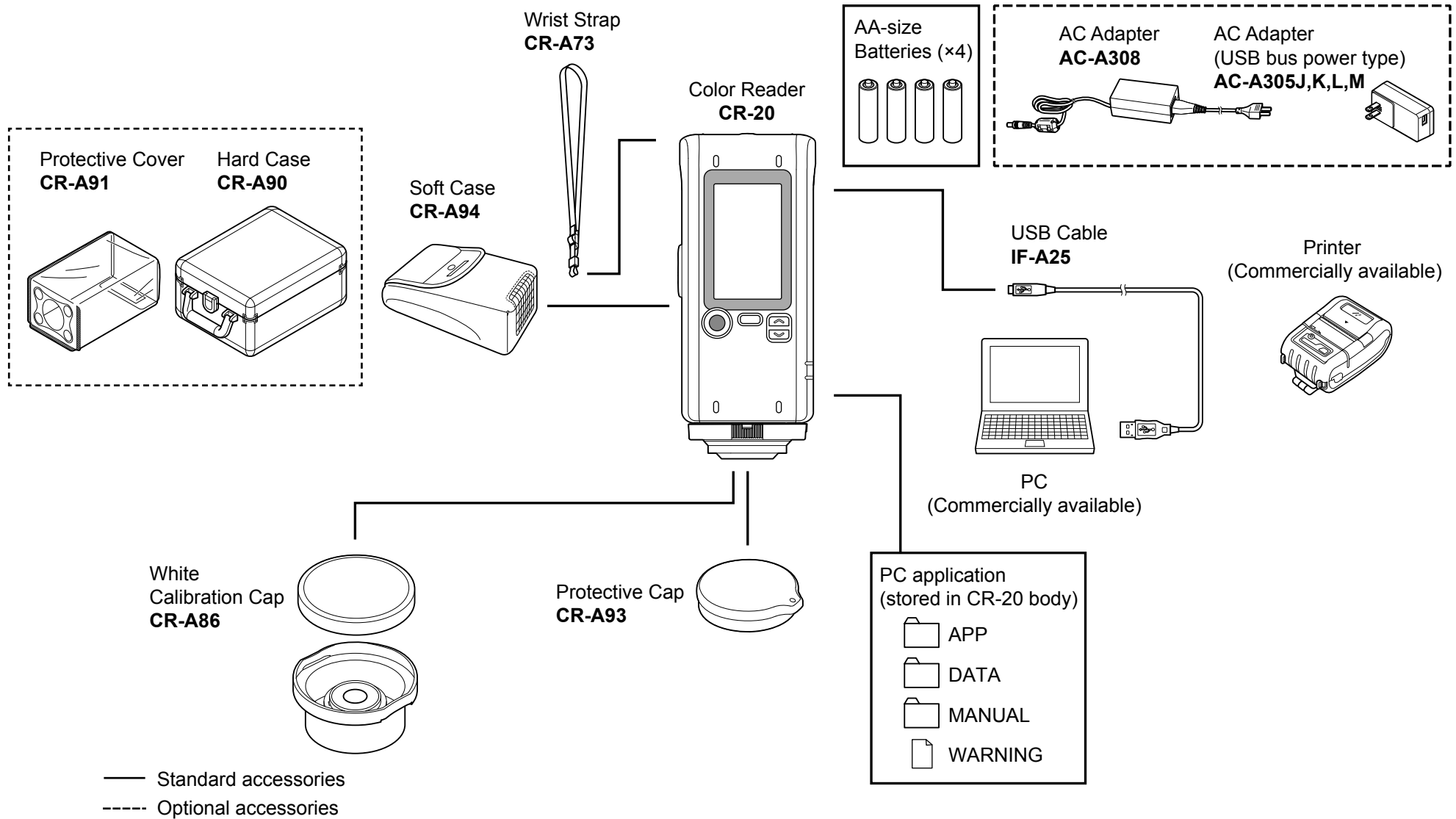

Names and Functions of Parts

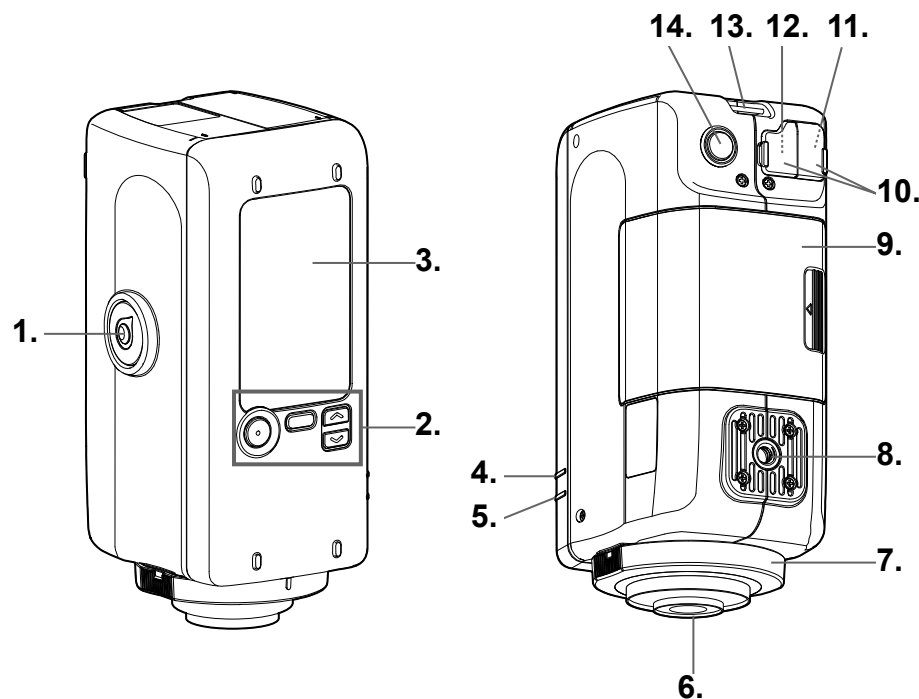

1. Measuring button

Press to calibrate or measure.

2. Operation keys

The keys are used to switch screens and to select, set, or save settings. See page 21 “Instrument Operation/Display” for details.

3. LCD screen

Displays settings, measurement results, messages, etc.

4. READY lamp (blue)

Displays the measurement ready status when charging of the emission circuit is complete.

5. STATUS lamp (orange)

Illuminates the lamp when measurement fails, when the xenon tube is burnt out, when operation cannot be performed, and for other error notifications.

6. Sample surface aperture

This is the aperture for measuring samples. The diameter of the opening can be changed by replacing the target mask.

7. Target mask

The target mask is used for aiming.

8. Tripod socket

9. Battery compartment cover

This is the cover for the battery compartment. Four AA batteries can be inserted into the battery compartment according to the polarity indications within.

10. Protective connector cover

Protects the AC adapter socket and USB connection terminal.

11. USB terminal

Used to connect the instrument to a PC or a printer (sold separately) when using the supplied USB cable (IF-A25).

12. AC adapter socket

Used to connect the AC adapter connector plug when using the optional AC adapter (AC-A308).

13. Strap holder

Used to attach the supplied wrist strap.

Memo See page 12, “Attaching the Wrist Strap”, in this manual for how to attach the wrist strap.

14. Power button

Used to turn the power ON/OFF. The power can be switched ON/OFF by pressing and holding this button.

Handling the Instrument

Attaching the Wrist Strap

Notes When using the instrument by hand, attach the wrist strap and pass your arm through the strap to prevent the unit from falling.

Procedure

- 1** Pass one end of the wrist strap through the strap holder on the instrument.
- 2** Pass the other end of the strap through the loop, and fold the end of the strap that was passed through the strap holder back through the loop as well.
- 3** Pass the end of the strap that was first passed through the loop through the buckle.
- 4** From the opposite direction of the end that was just passed through the buckle, also pass the other end of the strap through the buckle.

Memo When the strap is worn on the arm, move the loop as needed to tighten the strap as necessary.

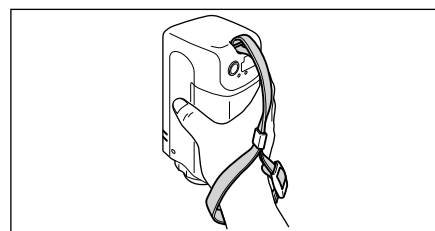
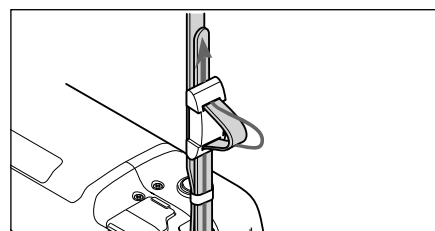
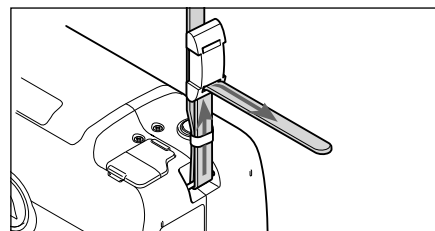
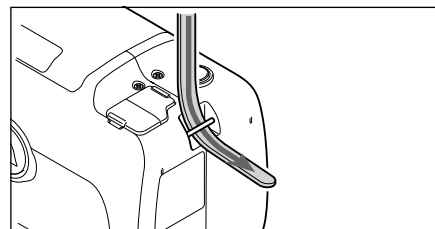

Handling the Instrument (Cont.)

Inserting Batteries

This instrument can be powered by four AA batteries (alkaline batteries or nickel-metal hydride rechargeable batteries). Use batteries as needed for the application.

- Notes**
- Do not use manganese batteries.
 - Remove the batteries if the instrument will not be used for at least 2 weeks. If the batteries are left in the instrument for long periods, the batteries may leak and damage the instrument.
 - Do not mix battery types or use a mixture of new batteries and used batteries. Doing so may cause the batteries to rupture or a decrease in battery life.
 - Do not touch or short-circuit the terminals in the battery compartment. Doing so may damage the instrument.

Procedure

- 1** Verify that the power has been turned OFF (LCD screen display is blank).

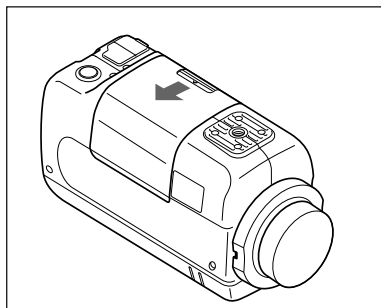

- 2** To open the battery compartment cover, slide the cover in the direction indicated by the arrow.

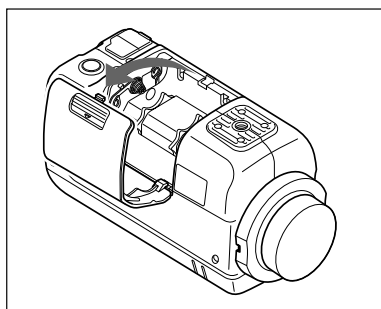

- 3** Insert four AA batteries according to the polarity indications shown in the battery compartment.

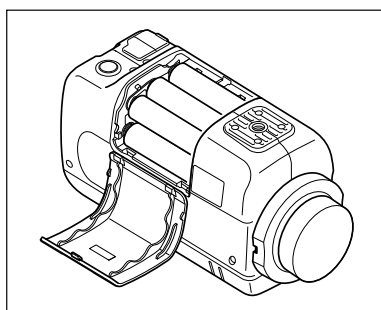

- 4** To close the cover, insert the protrusions on the cover in to the holes on the battery compartment on the instrument, and then press the cover in until it clicks.

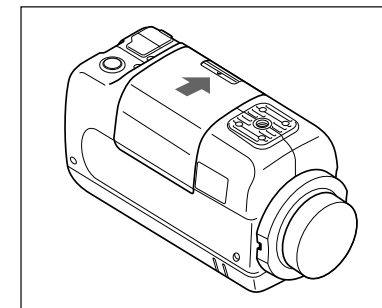

Powering from a PC

The included USB cable (IF-A25) can be used to connect the instrument to and power the instrument from a PC. Refer to “Connecting to a PC” on page 38 for details on connecting the instrument to a PC.

- Notes** When unplugging the USB cable from the instrument or the PC, be sure to verify that the instrument power has been turned OFF.

Handling the Instrument (Cont.)

Connecting an AC Adapter

- Notes**
- When using AC power for the instrument, be sure to use the optional AC adapter (AC-A308) or the USB bus power AC adapter (AC-A305J,K,L,M).
 - When connecting or disconnecting the plug, be sure to verify that the power has been turned OFF.

Memo Be sure to connect the AC adapter (AC-A305J,K,L,M) using the USB cable (IF-A25) supplied with the product.

When Using the AC Adapter (AC-A308) (Optional Accessory)

- 1** Verify that the power has been turned OFF (LCD screen display is blank).

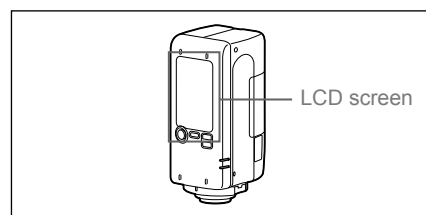

- 2** Close the protective connector cover for the AC adapter socket.

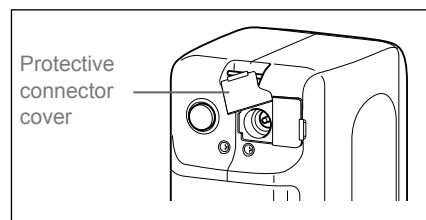

- 3** Connect the AC adapter connector plug to the AC adapter socket.

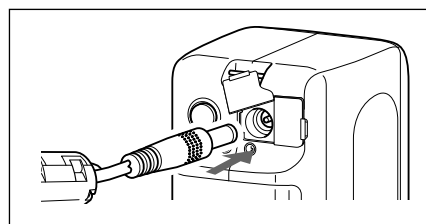

- 4** Plug the AC adapter power plug into a socket with 100 VAC (50/60 Hz).

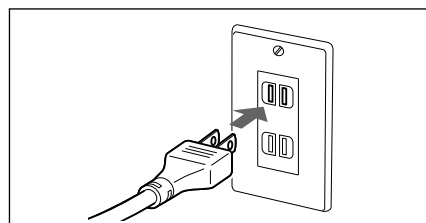

When Using the USB Bus Power AC Adapter (AC-A305J,K,L,M) (Optional Accessory)

Although the AC adapter plug can be connected and disconnected with the instrument power turned ON, in this section, the power is turned OFF before connection.

- 1** Verify that the power has been turned OFF.

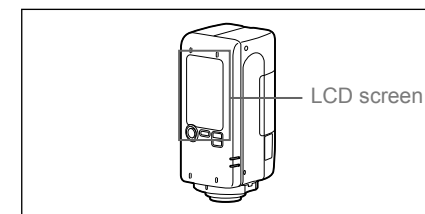

- 2** Plug the connector on the USB cable (A type) into the AC adapter.

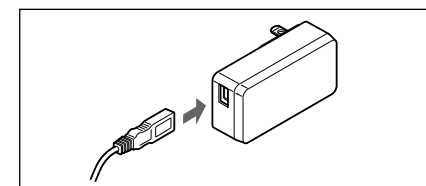

- 3** Connect the connector (B type) of the USB cable to the USB connection terminal.

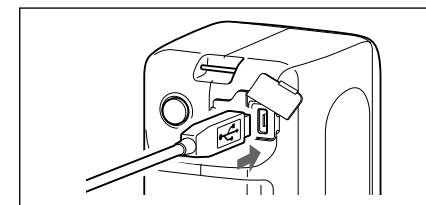

- 4** Plug the AC adapter power plug into a socket with 100 VAC (50/60 Hz).

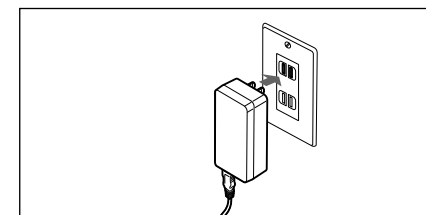

Handling the Instrument (Cont.)

Attaching/Removing the Target Mask

The following procedure explains how to attach or remove the target mask.

- Notes**
- Take care to prevent dust or the like from entering the integrating sphere from the sample surface aperture during operation.
 - Do not touch the inside surface of the integrating sphere painted white, use a cloth to wipe off dust or dirt, or put anything inside.
 - Do not apply excessive force to latch portion on the inside of the target mask. The target mask may become unusable if the latch portion is damaged.
 - If the target mask is damaged, contact a KONICA MINOLTA-authorized service facility.

Attaching to/Removing from Instrument

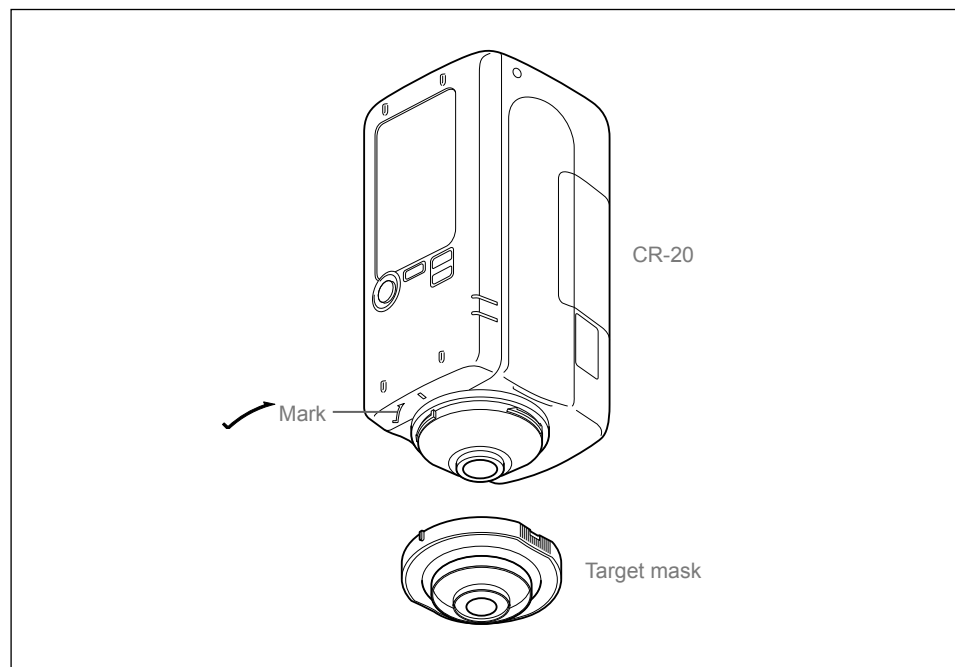

Attaching

- 1 Apply the target mask so that the protrusions on the outer perimeter of the target mask are aligned with the starting point of the ↗ mark used for aligning the instrument.
- 2 Hold the outer perimeter of the target mask, and rotate in the direction of the arrow (clockwise). Turn the target mask until the protrusion on the outer perimeter aligns with the | mark on the instrument and a clicking sound is heard. The target mask will be secured.

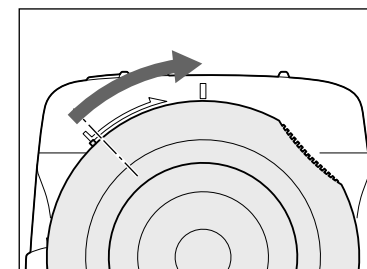

Removing

- 1 Hold the outer perimeter of the target mask, and rotate in the opposite direction of the arrow (counterclockwise) to remove the target mask. Rotate the mask until the protrusion on the outer perimeter reaches the starting point of the ↗ mark used for aligning the instrument.
- 2 Hold the outer perimeter of the target mask to remove it.

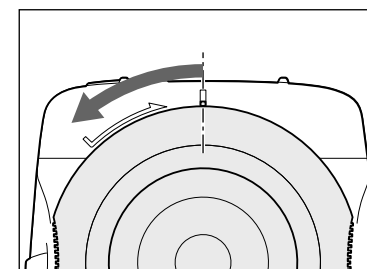

Handling the Instrument (Cont.)

White Calibration Cap CR-A86

The white calibration cap, constructed as shown below, is used for performing white calibration.

Notes • When the white calibration cap is not being used, keep it away from external light and dust by putting on the dedicated lid and storing it.

Attaching to/Removing from Instrument

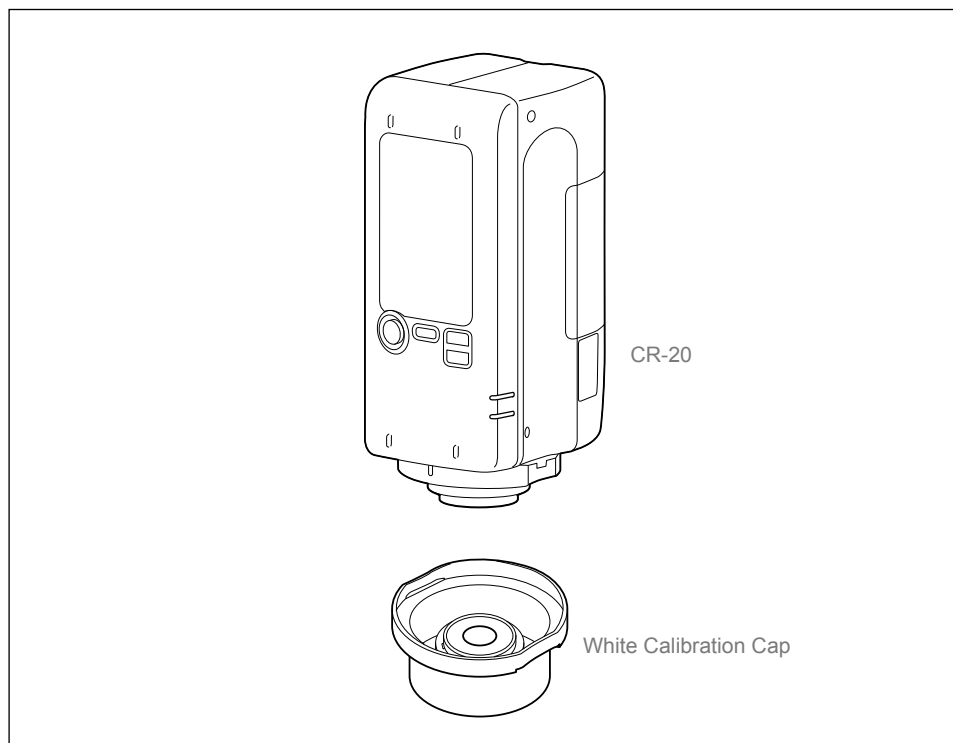

Attaching

- 1 Hold the instrument securely.
- 2 Place the white calibration cap with the white calibration area upward, and place the instrument on top so that the target mask fits over the white calibration area.

Notes Do not fix the target mask to the instrument.

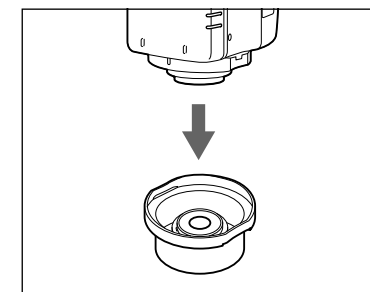

Removing

- 1 Remove the instrument from the white calibration cap, and attach the lid to the cap.

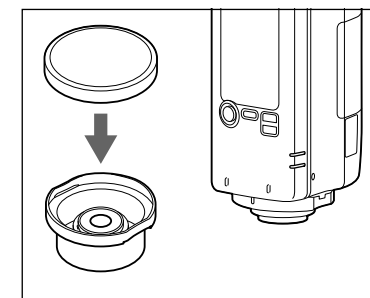

Handling the Instrument (Cont.)

Cleaning the Components

This section explains how to clean the target mask, the white calibration cap, and the inside of the integrating sphere.

Target Mask

- If the glass portion of the target mask becomes dirty, gently wipe the dirt off using a soft cloth. If the dirt does not come off easily, wipe using a cloth soaked in commercial lens cleaner, and then wipe using a cloth soaked in water before drying.
- If areas other than the glass become dirty, gently wipe the dirt off using a cloth soaked in water or soapy water. Never use solvents such as thinner or benzene.
- If the inside becomes dirty, blow off the dirt or dust using a blower.

Notes Do not touch the inside of the target mask or use a cloth to wipe off dust or dirt on the mask. If the target mask is dirty, and the dirt cannot be removed by a blower or the like, contact a KONICA MINOLTA-authorized service facility.

White Calibration Cap

- If the white calibration area becomes dirty, gently wipe the dirt off using a soft cloth. If the dirt does not come off easily, wipe using a cloth soaked in commercial lens cleaner, and then wipe using a cloth soaked in water before drying.
- If areas other than the white calibration area become dirty, gently wipe the dirt off using a cloth soaked in water or soapy water. Never use solvents such as thinner or benzene.

Notes Take care so as not to scratch the white calibration area.

Inside the Integrating Sphere

Procedure

- 1 Remove the target mask.

Memo See page 15, “Attaching/Removing the Target Mask” for how to remove the target mask.



- 2 Use a blower to blow off dust or dirt inside the integrating sphere.

Notes Do not touch, use a cloth to wipe off dust or dirt, or put anything inside the integrating sphere. If the target mask is dirty, and the dirt cannot be removed by a blower or the like, contact a KONICA MINOLTA-authorized service facility.

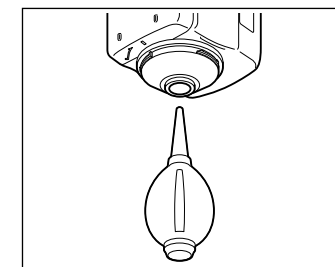

Handling the Instrument (Cont.)

Turning the Power ON/OFF

Turning the Power ON

- 1 Press and hold  for about 1 second.

The display on the LCD screen will appear and the READY lamp will illuminate in blue.

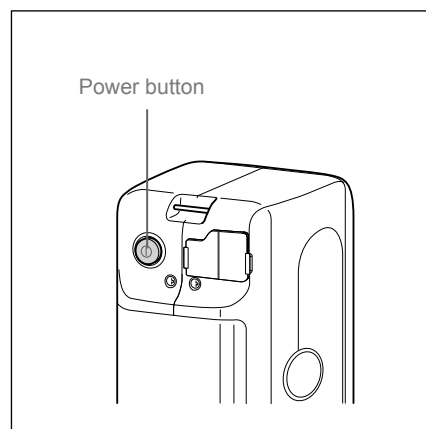

Turning the Power OFF

- 1 If the power is ON, press and hold  for about 1 second.

The display on the LCD screen will disappear.

- Memo**
- When shipped from the factory, the buzzer sound and READY lamp are set to ON.
 - The buzzer sound when the power is turned ON or when measuring can be changed to OFF using the PC application settings for the instrument. For details, see “*Settings Only Configurable from the PC Application” under Other Settings on pages 52 to 53.

Handling the Instrument (Cont.)

Display Language (When first turning the CR-20 ON)

When first turning the instrument ON after purchasing, a message that reads, "Please select language." will be displayed. One of two languages can be selected for the display language: English or Japanese.

(LCD screen)

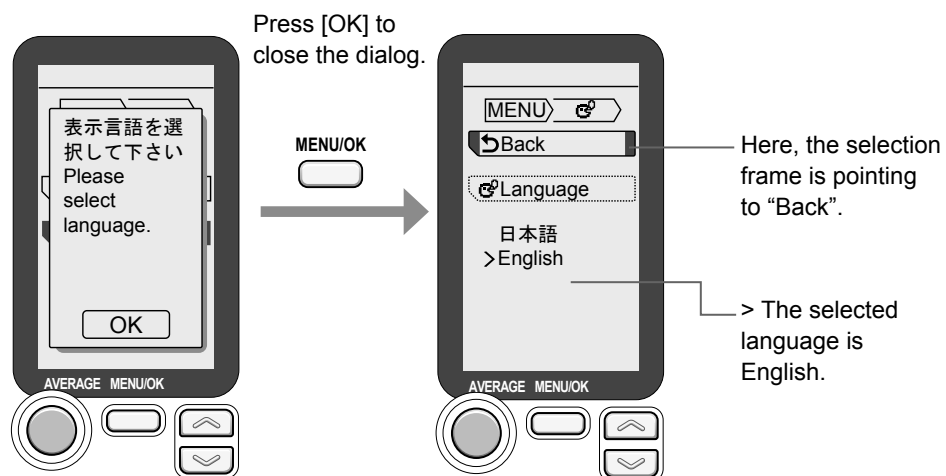

1 Select the desired language and confirm.



2 Go back to the <MENU> screen.



Handling the Instrument (Cont.)



Battery Warnings

This instrument can be powered by AA batteries (alkaline batteries or nickel-metal hydride rechargeable batteries).

When the instrument is operating on battery power, the battery mark will appear on the LCD screen showing one of two levels according to the battery consumption.

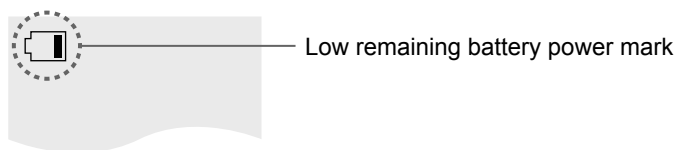
The battery mark will not be shown if the batteries have sufficient power.



Battery mark	Status	Description
	Batteries are depleted	The system will fail if the batteries are not replaced immediately. (The power will turn OFF automatically 5 seconds after the display appears.)
	Remaining battery power is low	If this mark is displayed, measurement can be continued temporarily, but new batteries should be installed as soon as possible.
None	Batteries are full	Shows that the remaining battery power is sufficient.

Memo The display will not be shown when the power is OFF.
The display will not be shown when power is supplied through the AC adapter or USB bus power.

Points to Remember

When using the instrument with the supplied PC application, the instrument's settings can be configured, measurement can be performed, and measurement data can be viewed in a list and saved/cleared.

Instrument Operation/Display

The LCD screen on the top of the instrument is used to display measurement results and messages. The operation keys can be used for configuring various settings used for measuring, for switching displays, and for other useful functions.

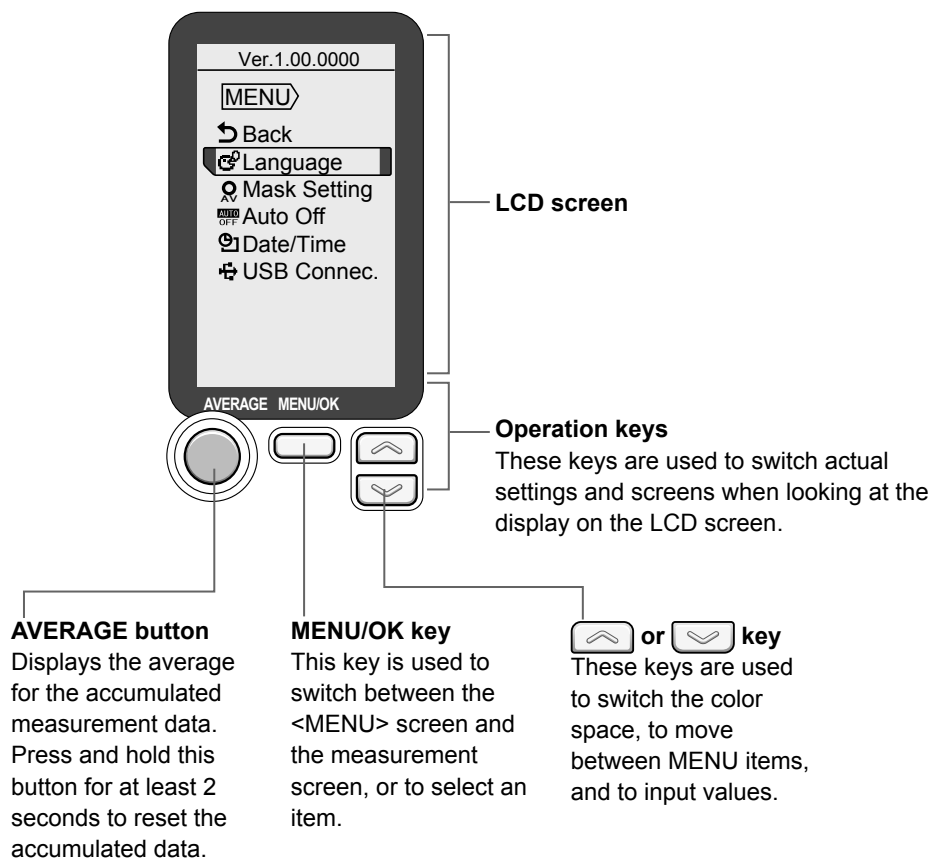

Display (LCD Screen)

The screen shows various settings used for measuring as well as measurement results, messages, and other information.

The instrument status is also displayed using icons. The following diagram shows the basic screen layout.

Measurement screen

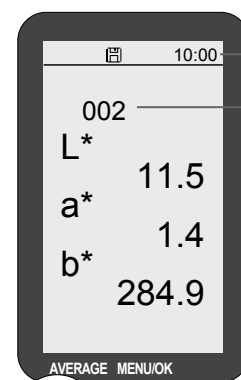

Status Indicator Icons

Displays the instrument status using icons.
* For details, refer to "Status Indicator Icons" on the next page.

Measurement/average display

Displays the measured color value or the average value.

The measurement results in the selected color space will be displayed here.

Memo Use the or key to switch the color space.

Setting screen



Status Indicator Icons

Displays the instrument status using icons.

Displays the selected MENU items.

Returns up one level (the <MENU> screen here, for instance).

Memo Pressing "Back" on the <MENU> screen will cause the display to switch to the measurement screen.

Displays the current settings.

- Press or to move the cursor and switch between settings.
- The item marked with ">" is the setting currently configured.

Points to Remember (Cont.)

Icon Displays (Status indicator icons/Measurement setting icons)

1. 2. 3. 4. 5. 6. 7.

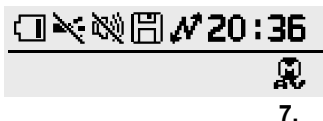

1. Battery status/USB power display
2. LED (READY lamp) OFF display
3. Buzzer mute display
4. Save the data to the instrument.
5. USB connection status
6. Clock
7. Target mask setting display

Turning ON/OFF Buzzer Sounds and the LED Lamp Display

When shipped from the factory, the buzzer sound and READY lamp are set to ON. However, these settings can be changed using the supplied PC application. For how to configure these settings, read the information regarding turning the PC application environment settings buzzer ON/OFF (Page 52) and regarding the display LED (READY lamp) display (Page 53).

Pairing Number

The instrument and white calibration cap bear 5-digit numbers called “pairing number”. Before starting white calibration, confirm that the instrument and white calibration cap have the same pairing number.

1.	None	Shows that the remaining battery power is sufficient.
		Shows that the remaining battery level is low. Replace the batteries.
		The system will fail if the batteries are not replaced immediately. (The power will turn off automatically 5 seconds after the display appears.)
		Power is being supplied through the USB cable.
2.		LED OFF (*Displayed when set to OFF from the PC application.)
3.		Buzzer mute (*Displayed when set to OFF from the PC application.)
4.		Measurement data is being saved to the instrument.
5.		Shows that the instrument is attached to a PC.
		Shows that the instrument is attached to a printer.
6.	20:36	Time setting
7.		Mask setting (MAV fixed)

White Calibration Cap

CR-20

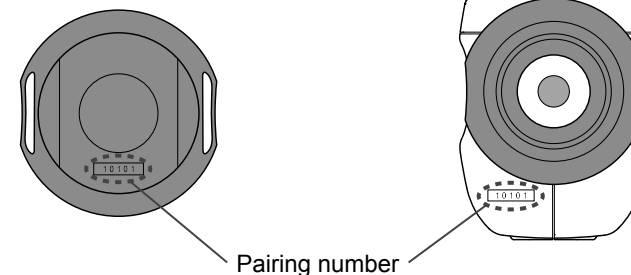

The instrument and white calibration cap to be used together must have the same pairing number.

Instrument Info Display

Checking CR-20 Information

Checking Instrument Firmware Version

The information will be displayed at the top of the <MENU> screen.
Ex.: Ver.1.00.0000



Checking the Serial Number

The 7-digit serial number is written on the nameplate on the top of the instrument.

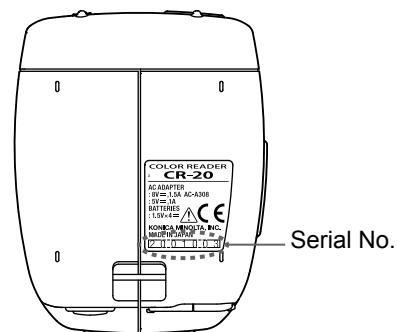

Chapter 2

Measurement

Notes Verify that the USB cable is connected or that there is sufficient battery power remaining before performing measurement.

CAUTION To ensure correct measurement, take care to prevent the sample and the sample from slipping away from the sample surface aperture while pressing down the measuring button.

Flow of Measurement

■ Basic procedure

■ Optional settings

Perform items marked with (*) using the PC application.

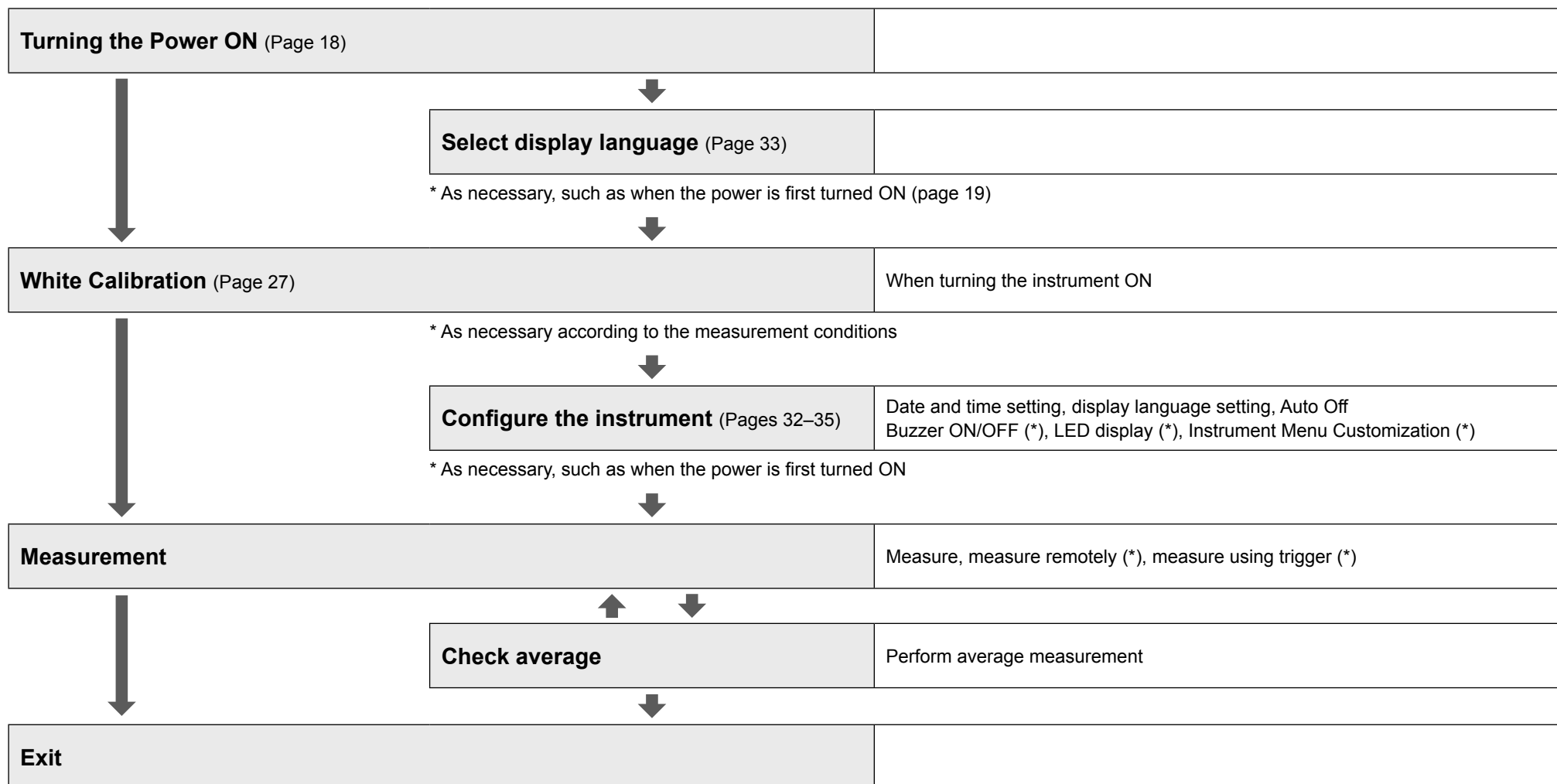

Part 1. Measurement

Memo Some settings can be configured on the instrument when turned ON in the settings of the supplied PC application.
For more on these settings, read “Instrument Menu Customization” regarding the environment settings for the instrument (Page 54).

White Calibration

This instrument requires white calibration before performing measurement after the power is turned ON.

Memo • Changes in ambient temperature and heat generated from repetitive use may cause subtle deviations in the indicated values. In such cases, perform white calibration regularly.

Notes • **Perform white calibration using the included white calibration cap.**
 • **Perform white calibration under the same temperature conditions as when performing measurement.**
 • **Perform white calibration after the instrument has had time to adapt to the ambient temperature.**

Memo When the buzzer is set to ON, the buzzer will emit a sound during measurement. The following explanations assume that the buzzer sound has been set to ON.

1 Turn the instrument power ON.

2 Place the instrument on the white calibration cap.

Memo • See page 16 for how to attach the white calibration cap.
 • When performing white calibration, confirm that the instrument and white calibration cap have the same pairing number (See page 22).

3 Press the measuring button.

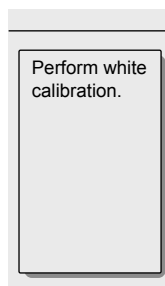
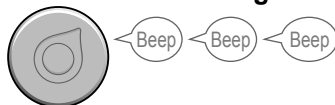

4 White calibration will be performed, and the measurement screen will be displayed.

Memo Remove the instrument from the white calibration cap. Put the dedicated lid on the white calibration cap, and store the cap in the storage case.

Memo When a calibration error occurs, the buzzer will beep three times on the third try, and "Calibration Error" will be displayed. Click the MENU/OK button, check that the white calibration cap is correctly attached and that it has the same pairing number as the instrument, and perform white calibration again.

5 Perform measurement to continue.

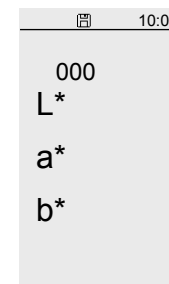

Measurement

Notes Make sure to perform white calibration before measuring. For details, refer to “White Calibration” on page 27.

- For accurate measurements, measure under the same conditions (ambient temperature, etc.).

1 Verify that the <Measurement> screen is displayed.

```

000
L*
a*
b*
  
```

2 Set the sample surface aperture on the sample to measure.

3 Press the measuring button.



4 Measurement will be performed, and the measurement results will be displayed on the screen.

Continue performing measurements to measure more than once.

To perform measurement again, press MENU/OK and navigate to “Undo” to perform the measurement again.

```

001
L* 30.1
a* -0.2
b* -3.8
  
```

Notes Measurement results that exceed the range of guaranteed performance will be displayed as in the following diagram.

Take care when using these measurements.

```

001
L* 9.6
a* -8.8
b* -23.7
  
```

Avg. Meas.

Using the average measurement function makes it possible to obtain data that is even more accurate.

If the sample color is uneven, the accuracy of the measurement can be improved by randomly measuring locations within the sample area to calculate the average for the sample, or by repeatedly measuring the same sample location to calculate the average for that location.

Notes After an average is determined for the instrument, because the average is converted for each color space and displayed, the simple averages for measurements of each count may not match.

1 Verify that the <Measurement> screen is displayed.

If the measurement count does not read "000", pressing and holding the AVERAGE button will clear the display.

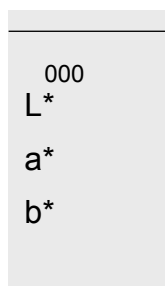

2 Set the sample surface aperture on the sample to measure.

3 Press the measuring button.



4 Measurement will be performed, and the measurement results will be displayed on the screen.

Continue performing measurements to measure more than once.

To perform measurement again, press MENU/OK and navigate to "Undo" to perform the measurement again.

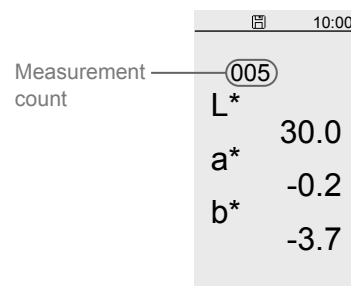

5 While the measurement is displayed, quickly press the AVERAGE button.

The average of the measurement results up to that point will be displayed.

Press the measurement button again to continue measuring.

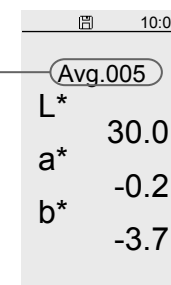

Indicates that values are average for five measurements



6 Reset the average.

Press and hold the AVERAGE button for at least 1 second to reset the measurement results.



Memo

It is also possible to reset the results by navigating to the MENU screen and pressing  or  to select Avg. Reset.

Switching Measurement Result Displays

It is possible to switch between color spaces and index displays for the measurement results.

Select the color space or index (WI, Tint, or YI) to be used.

1 On the measurement screen or the measurements results display screen, press  or  to switch the color space.

<Display examples>

L*a*b*
color space

005	
L*	94.9
a*	-0.4
b*	4.7

L*C*h
color space

005	
L*	94.9
C*	4.7
h	95.4

Yxy
color space

005	
Y	87.4
x	0.3215
y	0.3400

XYZ
color space

005	
X	82.6
Y	87.4
Z	87.0

Munsell
color space

005	
H	5.0Y
V	9.4
C	0.6

WI (CIE/ASTM E 313-96)
Tint (CIE/ASTM E 313-96)
YI (ASTM E 313-96)

005	
WI	65.9
Ti	-1.0
YI	8.6

"●" is displayed if the value exceeds the defined range determined by the standard.

Setting

Initial Setting	Setting	Color space/Index
●	L*a*b*	L*a*b* color space
	L*C*h	L*C*h color space
	Yxy	Yxy color space
	XYZ	XYZ color space
	HVC	Munsell color space
	WI, Ti, YI	WI (CIE/ASTM E 313-96) Tint (CIE/ASTM E 313-96) YI (ASTM E 313-96)

Part 2. Instrument Settings

Various Settings/Instrument Settings

Mask Setting	Instrument Menu Customization
— Configure as necessary —	ON  Mask Setting

“Auto Detect” is set under Mask Setting on the instrument when shipped from the factory. If for some reason automatic detection is not possible, configure the settings appropriately for the target mask attached.

- When “Mask Setting” is not displayed in the menu, refer to page 54 and turn the setting “ON” in the Instrument Menu Customization settings.

1 Go to the <MENU> screen.

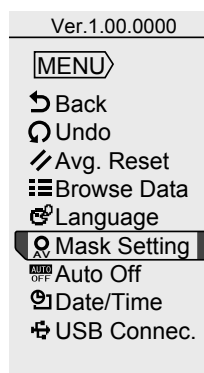

2 Select “Mask Setting” and confirm.

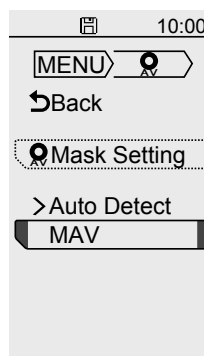

3 Select the type of target mask attached, and confirm.



4 Go back to the <MENU> screen.



5 Go back to the measurement screen.

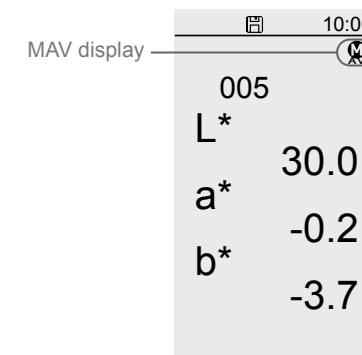

Setting

Initial Setting	Setting	Details
•	Auto Detect	The attached target mask will be automatically detected. This is the recommended setting.
	MAV	When the target mask cannot be detected automatically, configure the settings appropriately for the target mask attached.

Various Settings/Other Settings

Language	
— Configure as necessary —	

It is possible to change the display language

1 Go to the <MENU> screen.

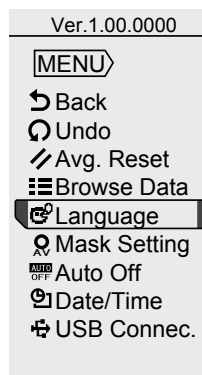

2 Select “Language” and confirm.



3 Select the desired display language and confirm.



4 Go back to the <MENU> screen.



5 Go back to the measurement screen.



Setting

Initial Setting	Setting
	Japanese
•	English

Various Settings/Other Settings (Cont.)

Auto Off	Instrument Menu Customization
— Configure as necessary —	ON  Auto Off

The instrument includes an Auto Off function. When using battery power, this function automatically turns the power OFF if the operation keys are not operated within the specified time.

Memo • When “Auto Off” is not displayed in the menu, refer to page 54 and turn the setting “ON” in the Instrument Menu Customization settings.

1 Go to the <MENU> screen.



2 Select “Auto Off” and confirm.

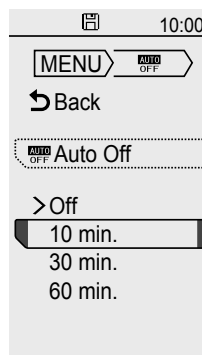

3 Select the desired setting and confirm.



4 Go back to the <MENU> screen.



5 Go back to the measurement screen.



Setting

Initial Setting	Setting	Details
•	Off	Auto Off will not be performed.
	10 min.	The power will turn OFF automatically if the operation keys are not operated within 10 minutes.
	30 min.	The power will turn OFF automatically if the operation keys are not operated within 30 minutes.
	60 min.	The power will turn OFF automatically if the operation keys are not operated within 60 minutes.

Various Settings/Other Settings (Cont.)

Date and Time Setting

— Configure as necessary —

Save to Instrument

- Memo**
- This setting is only displayed and usable when the “Save to Instrument” setting for saved data is turned ON using the PC application.
 - The instrument is equipped with an internal clock used to record the date and time of a measurement when measurement is performed.

1 Go to the <MENU> screen.



2 Select “Date/Time” and confirm.

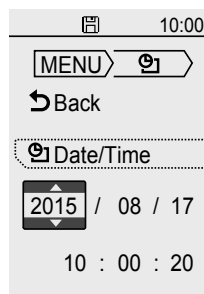

3 Select the desired setting and confirm.



Press to switch the values to ascending order, and press to switch to descending order.

Press after changing each item.

Pressing when the selection frame is on the rightmost item (seconds) will confirm all items.

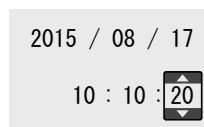

4 Go back to the <MENU> screen.



5 Go back to the measurement screen.



	10:00
005	
L*	30.0
a*	-0.2
b*	-3.7

Setting

Year	2000–2099
Month	01–12
Day	01–31
Hour	00–23
Minute	00–59
Second	00–59

Measurement Data Operations

Browse Data	<input checked="" type="checkbox"/> Save to Instrument

It is possible to view the details of data saved to the instrument.

Memo • This setting is only displayed and usable when the “Save to Instrument” setting for saved data is turned ON using the PC application and data is saved.

1 Go to the <MENU> screen.

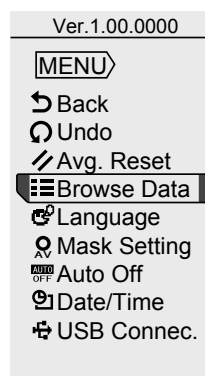

2 Select “Browse Data” and confirm.



3 The most recent measurement results are displayed along with the date and time the data was obtained.

Press to switch to the next saved data in ascending order, and press to switch to the next data in descending order.

Data totals and the order in which displayed data was obtained will be displayed in the upper left corner of the screen.

Memo Results are displayed in the currently selected color space. To change the displayed color space, press the MENU/OK button, and from the measurement screen press or to switch the color space before browsing for data.

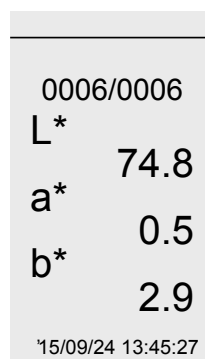

Chapter 3

PC Application

Notes on Use

- This software is application software for use with Windows 7, Windows 8, or Windows 8.1. Please note that this software does not include any OS.
- One of the above OS must be installed on the PC in order to install this software.
- Refer to page 74 for PC system requirements.

Connecting to a PC

This instrument is equipped with a USB connection terminal.

The included USB cable (IF-A25) can be used to connect the instrument to a PC and transmit data as well as to allow the instrument to be controlled or configured from a PC application.

- Notes**
- Do not connect any cable other than the designated cable to the USB connection terminal.
 - When connected via USB and communicating, communications may be interrupted by being exposed to strong external static electricity or radio waves from the surrounding area. In such cases, turn the power OFF and then turn it ON again.
 - Firmly connect the USB connector plug in the correct orientation.
 - Always connect and disconnect the USB cable by the connector's plug. Do not pull it out by the cable itself or bend it with unreasonable force. Doing so may break the cable.
 - Connect the instrument using a cable with a suitable length. If the cable is not of a suitable length, connection problems may arise or the cable may break.
 - Firmly push in the USB cable connector that matches the shape of the port (connection terminal) until it can go in no further.
 - With Windows 8.1, if the instrument can only be operated using USB Feed, set "USB selective suspend setting" under Power Options to "Disabled".

- Memo**
- The USB communication port on the instrument is USB 2.0-compliant.

Connecting to/Disconnecting from a PC

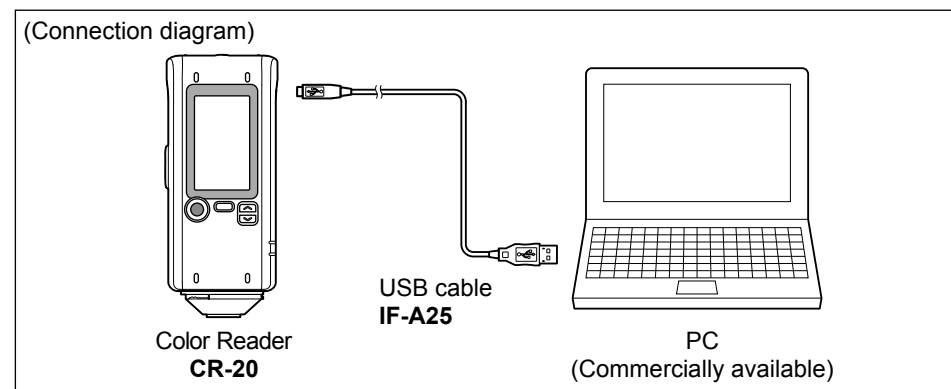

Connecting to a PC

Operating Procedure

- 1 Connect the Micro-B connector of the USB cable to the USB connection terminal on the instrument.
Firmly push it in until it can go no further and verify that it is securely connected.
- 2 Verify that the instrument power has been turned ON.
- 3 Press , move the selection frame to "USB Connec.," using either or , and then press .



Connecting to a PC (Cont.)

- ④ Move the selection frame to “PC” using either  or , and then press .

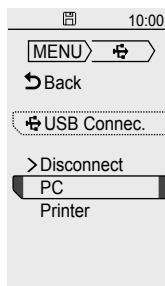

“Connecting to PC” will be displayed on the instrument.

Memo Pressing the MENU/OK key while “Connecting to PC” is displayed on the screen will cause the instrument to be disconnected from the PC.

- ⑤ **Connect the A connector of the USB cable to the USB port on the PC.**

After connecting to the PC, the instrument will be recognized as a mass storage device, and an AutoPlay dialog box will be displayed.

Memo If the instrument is not recognized as a mass storage device, disconnect and reconnect the cable, and start the procedure over again from step 2.

When First Connecting to the PC

- Notes**
- To use a PC application with the instrument connected to a PC, the dedicated USB driver must be installed.
 - If the PC being used is connected to the Internet, the Windows updater will be used to automatically install the drivers.
 - Installation may take several minutes.
 - Once installation is complete, a COM port will be assigned to the instrument.

If the PC is not connected to the Internet, manually install the drivers by accessing the APP folder in the instrument’s mass storage folder.

- ① **Checking the connection status (COM port number)**

[Windows 7]

Navigate to [Start menu] → [Computer] (right-click) → [Properties] → [Device Manager] → [Ports (COM & LPT)].

⇒ Measuring Instruments(COM**): The COM port number assigned to the instrument will be displayed for “**”.

[Windows 8]

Move the mouse to the lower left of the screen, right-click on the displayed window, and navigate to [Device Manager] → [Ports (COM & LPT)].

⇒ Measuring Instruments(COM**): The COM port number assigned to the instrument will be displayed for “**”.

[Windows 8.1]

Right-click on the Start button in the lower-left corner of the screen, and navigate to [Device Manager] → [Ports (COM & LPT)].

⇒ Measuring Instruments(COM**): The COM port number assigned to the instrument will be displayed for “**”.

Regardless of the PC’s OS, if the connected instrument is not displayed under [Ports (COM & LPT)] and is instead displayed as an “Unknown device” with an “!” mark, follow the procedure under “Updating the drive manually”.

Connecting to a PC (Cont.)

② Updating the drive manually

If the connected instrument is not displayed under [Ports (COM & LPT)] and is instead displayed under [Other Devices] as “! Unknown Device”, the USB driver will need to be installed manually.

②-1 Right-click on the unknown device marked with “!”

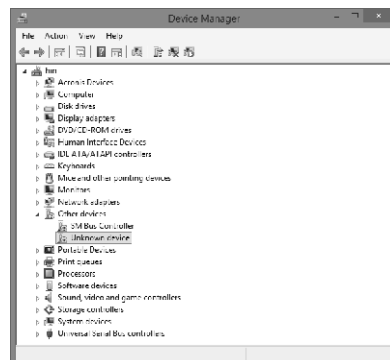

②-2 Select [Update Driver Software], and click “Locate and install driver software manually.”

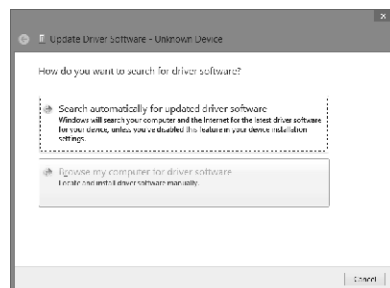

②-3 Specify the APP folder in the instrument’s mass storage folder as the save destination, and click “Next”.

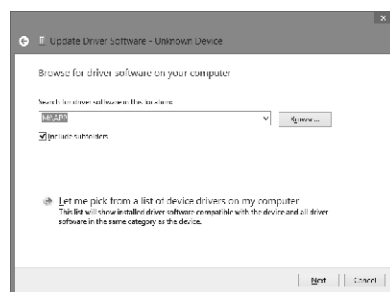

Click “Install” on the confirmation screen with the message that reads, “Would you like to install this device software?”

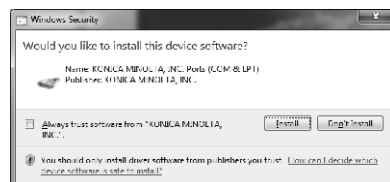

After installing, click “Close”.

②-4 Confirm the COM port number from step 1, and then navigate to [Device Manager] → [Ports (COM & LPT)]. If “Measuring Instruments(COM**)” is displayed, driver update has been completed.

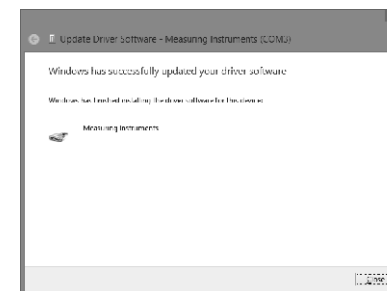

Disconnecting from a PC

Operating Procedure

- 1 Press **MENU/OK** when “Connecting to PC” is displayed on the instrument. The instrument will be disconnected from the PC, and the display will return to the measurement screen.

Memo If the PC application is running, the PC application will also be exited. Click “OK” when the following message is displayed.

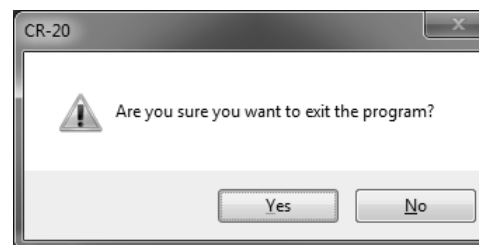
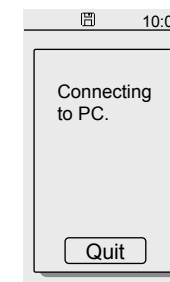

Connecting to a PC (Cont.)

Launching the PC Application

Memo The PC application cannot be run when logged in to the PC under a “Guest” account.

Notes [Windows8/8.1]
When starting the PC application, if “.NET Framework 3.5” is requested, follow the procedure below to configure the settings.

(Procedure)

Under [Control Panel] → [Programs and Features], select “Turn Windows features on or off”.

In the Windows Features window, check the box next to “.NET Framework 3.5” and click “OK”. Follow the displayed procedure to install.

If this installation is not completed properly, be sure to verify that Windows Update works as it should.

1 When connecting to a PC, an AutoPlay dialog will be displayed. Click “Open folder to view files”

Notes Writing to the instrument memory is not permitted. Note that even if files are moved they will not be saved to the instrument.

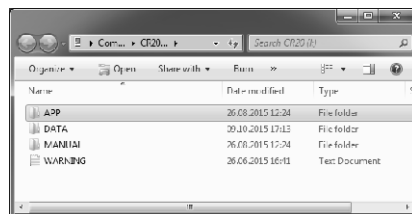

2 Copy the “CRX_APP.exe” file in the APP folder and the MANUAL folder to the PC’s hard drive.

Notes If the PC application is run from within the APP folder, some functions may not be usable depending on the PC. Copy the file to the PC’s hard drive before using.

3 Double-click the “CRX_APP.exe” file copied to the PC’s hard drive to launch the PC application.

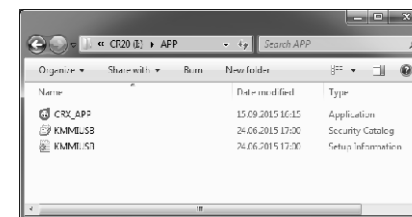

Notes If a screen similar to the following appears, click “OK” to close the dialog, and reconnect the instrument via USB.

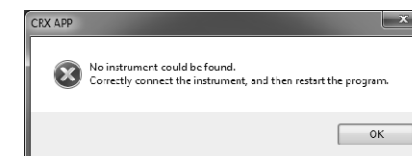

Memo The PC application does not support connections to multiple instruments.

Exiting the PC Application

1 Click in the upper-right corner of the PC application, or click “Exit”.

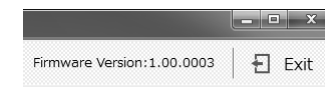

2 When a message asking, “Are you sure you want to exit the program?” is displayed, click “Yes”.

You will be exited out of the PC application.

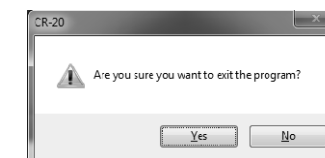

Notes When disconnecting the USB cable, be sure to exit the PC application or turn OFF the instrument power first.

Points to Remember

PC Application Settings

Using the supplied PC application, the items displayed on the instrument's menus can be customized.

Change the settings as required.

Settings for the instrument can be configured through the “**Setting**” screen on the PC application.

The items that appear on the instrument's settings menu are as follows.

(Settings marked with © are items that may be displayed or hidden depending on settings in the PC application. These settings are hidden by default.)

MENU	Setting	Details
Back	Back	
Undo		Allows the measurement to be redone during averaging measurements. This item is only displayed when average measurement data is present.
Avg. Reset		This function resets the number of measurements for determining the average.
© Browse Data	Results Display	Allows the data saved to the instrument to be viewed. This item is only displayed when saved data is present.
Language	Japanese English	
© Mask Setting	Auto Detect MAV	This function configures the target mask. It is usually set to Auto Detect.
© Auto Off	Off 10 min. 30 min. 60 min.	This setting allows the power to be turned OFF automatically if the instrument is not operated within the set number of minutes.
© Date/Time	yyyy/mm/dd hh:mm:ss	This is displayed when saving data from the PC application to the instrument has been enabled.
USB Connc.	Disconnect PC Printer	This function is used when an external device is connected.

Points to Remember (Cont.)

PC Application Operation Screen

The supplied PC application is configured with three operation panels: "Setting", "Measure", and "Data". The following describes the functions available on each screen.

Memo The settings configured using the PC application are reflected on the instrument.

[Setting] Tab

Allows configuration of the instrument environment.

Memo The settings configured on the PC application will also be applied when measuring remotely from the PC application.

Buzzer
Switches the buzzer sound ON/OFF.
(Page 52)

LED
Switches the display status of the READY lamp and STATUS lamp.
(Page 53)

Auto Off
When using battery power, this function automatically turns the power OFF if the operation keys are not operated within the specified time.
(Page 50)



Instrument Info Display
Displays the instrument's serial number and firmware version.

Exit button
Click this button to exit the PC application.

Save Meas. Data
Set whether to save measurement data to the instrument.

Language
The display language for the PC application and the instrument can be set to either English or Japanese.
(Page 49)

Date/Time
Obtain and display the date and time from the instrument. The PC's date and time can also be set to the instrument.
(Page 51)

Inst. Menu Customization
This function enables certain settings to be configured on the instrument. Items switched to ON will be configurable on the instrument.
(Page 54)

Points to Remember (Cont.)

[Measure] Tab

Measurement can be performed when the instrument settings are met and the PC application is running.

Memo The settings configured on the PC application will also be applied when measuring remotely from the PC application.
When performing remote measurement from the PC application, the “Meas. Cond.” on the left side of the screen will be applied.

Mask
Configures the target mask for the instrument. (Page 47)

Avg. Meas.
Switching to this tab will display the average for successively measured data.

Use Measure Button on Inst.
Checking the box on the right enables measurement through the measuring button on the instrument.

Memo The “Measure” key on the PC application is disabled.

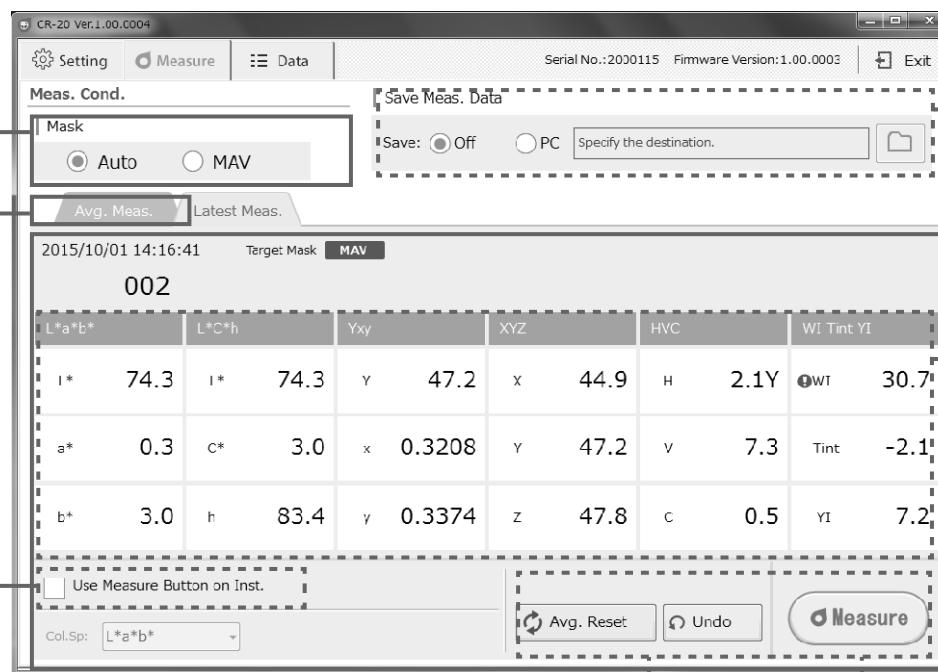

Save Meas. Data
Specifies the destination for saving data measured using the PC application. It is also possible to configure the settings so that measured data is not saved.

Latest Meas.
Displays the most recent measurement data.

Avg. Reset
This function resets the successively measured data used for determining the average.

Undo
This function allows measurement to be redone during averaging measurements.

Measure
Measures remotely from the PC application.

Points to Remember (Cont.)

[Data] Tab

Functions related to measurement data saved to the instrument are available in the [Data] tab. This tab allows data saved in the instrument to be imported and displayed as a list before being saved to the PC.

Data Saved in Inst.

Read

All data saved in the instrument is referenced and displayed in a list.

Save to PC

Import data saved in the instrument to a specified destination.

Clear Inst. Data

Delete all data saved in the instrument. Performing this operation will clear the list.

Folder List

Displays a folder view of imported data according to date and time of measurement.

Displays the measured data for the date and time selected (marked in blue) in the above folder list.

- **Del. Folder**

Deletes the selected folder. If a folder is deleted, the data measured on the day of the folder name will also be deleted.

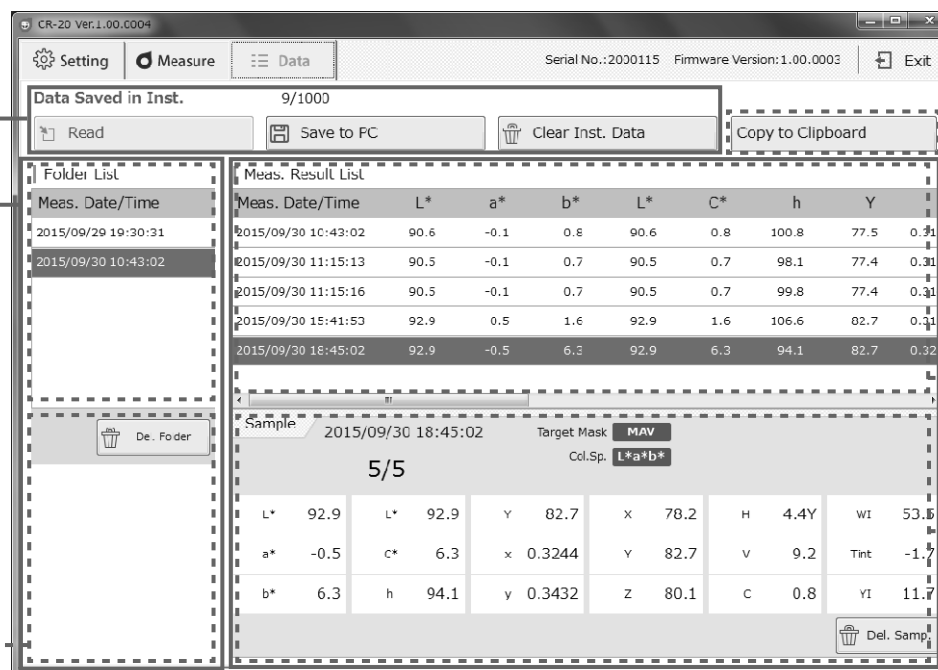

Copy to Clipboard

Copies all measurement data (data displayed in the measurement results list) within the folder selected in the folder list to the clipboard.

Measurement result list display area

Meas. Result List

Displays all the data within the folder selected in the folder list in a list.

Displays the information for the data selected in the above Meas. Result List (data marked in blue).

- **Target Mask**

Displays the target mask at the time of measurement for the displayed data.

- **Col.Sp.**

Displays the color space used at the time of measurement for the displayed data.

- **Del. Samp.**

Deletes the sample data selected in the measurement results list.

Instrument Info Display

Checking CR-20 Information

The instrument information and version of an instrument connected to the PC can be checked on the PC application screen.

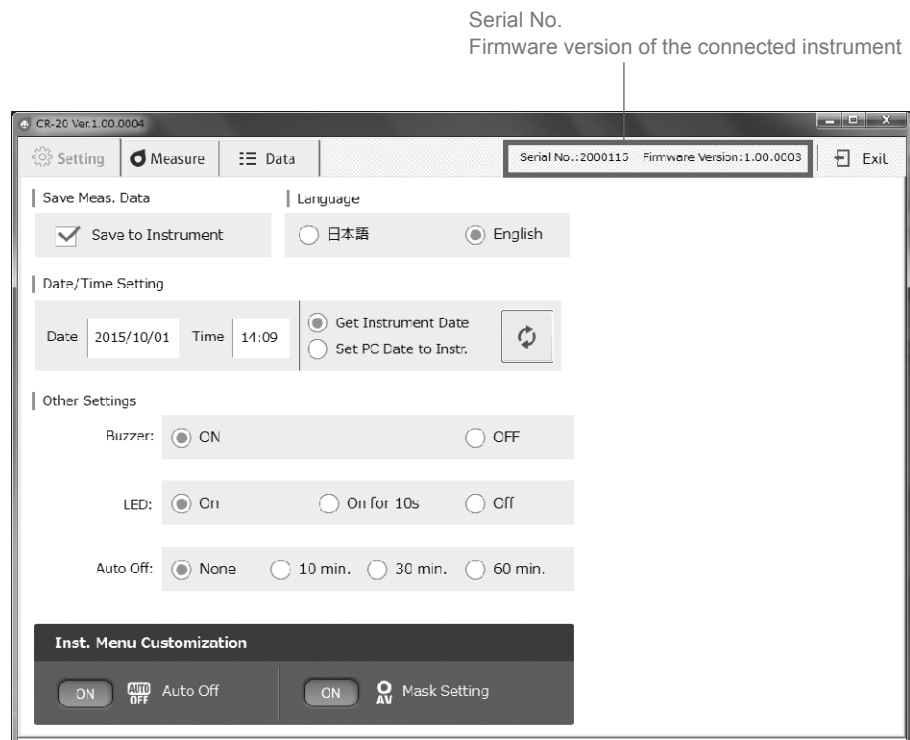

Instrument Settings

Mask Setting	Instrument Menu Customization
— Configure as necessary —	ON <input type="radio"/> AV <input checked="" type="radio"/> Mask Setting

“Auto Detect” is set under Mask Setting on the instrument when shipped from the factory. If for some reason automatic detection is not possible, configure the settings appropriately for the target mask attached.

In such cases, automatic mask detection will be turned OFF. No warning will be generated even if the attached mask is different from that set. Take careful care when using.

1 Go to the “Measure” screen.



2 Select the type of target mask attached.

Auto MAV

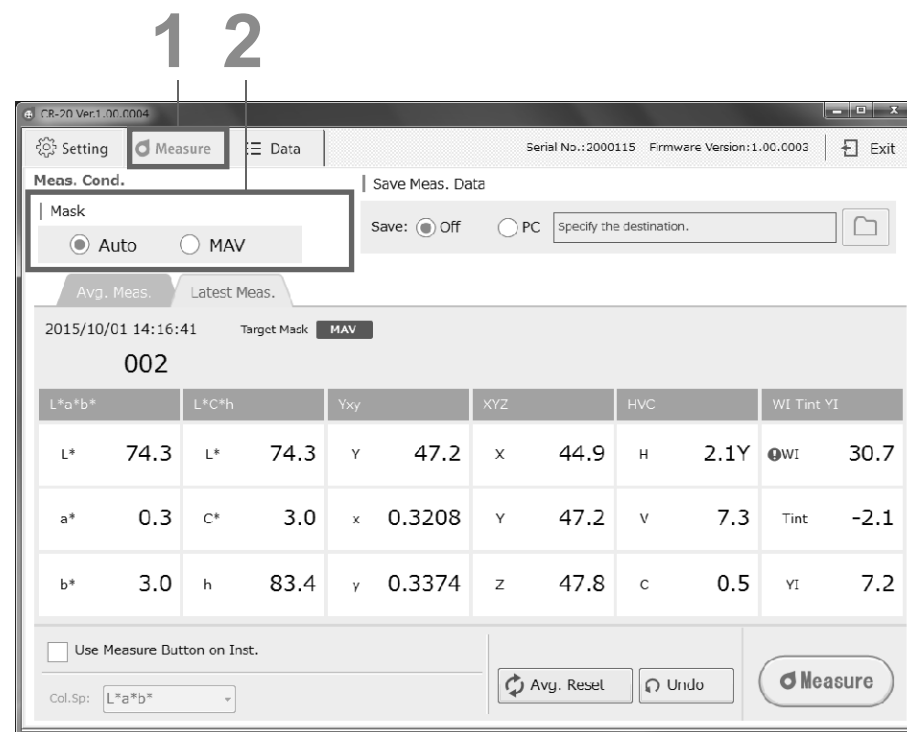

Setting

Initial Setting	Setting	Details
•	Auto	The attached target mask will be automatically detected. This is the recommended setting.
	MAV	When the target mask cannot be detected automatically, configure the settings appropriately for the target mask attached.

Environment Settings (Changing Instrument Settings)

Save Meas. Data

Measured data can be saved to the instrument.

1 Go to the “Setting” screen.

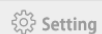

2 Click the check box to the left of “Save to Instrument”.

Up to 1000 measurement data entries can be saved. In addition, this application can be used to display data saved in the instrument in a list and to save the data to the PC.

Also note that saved measurement data will be saved to the instrument’s mass storage folder and that the folders can be copied directly to the PC’s hard drive using drag-and-drop functionality.

Save destination folder: “DATA” folder inside the instrument’s mass storage folder

— Measurement date (yyyymmdd) folder — File name: numbered according to measurement order

Example: 132648.csv (measurement hhmss)

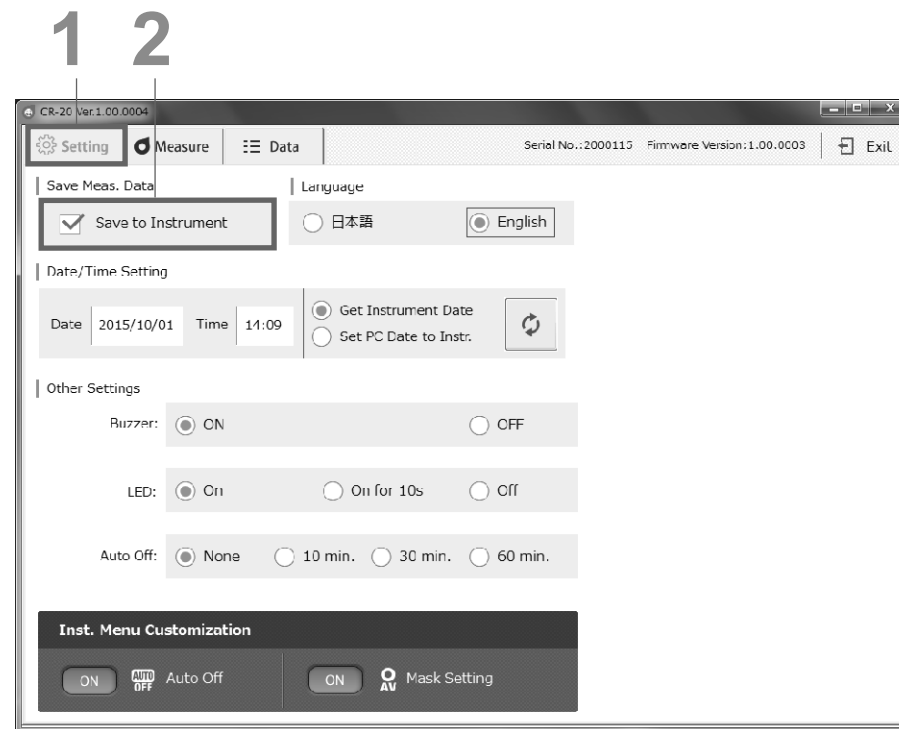

Environment Settings (Changing Instrument Settings) (Cont.)

Language

— Configure as necessary —

It is possible to change the display language

1 Go to the “Setting” screen.



2 Select the desired language under “Language”.

Click ○.

The radial will change to ⊙, and the language will be selected.

Clicking this will cause the display language for the PC application and the instrument to change simultaneously.



Setting

Initial Setting	Setting
	Japanese
●	English

Environment Settings (Changing Instrument Settings) (Cont.)

Auto Off

— Configure as necessary —

The instrument includes an Auto Off function. When the instrument is using battery power, this function automatically turns the power OFF if the operation keys are not operated within the specified time. The Auto Off function can be switched ON/OFF.

1 Go to the “Setting” screen.



2 Select the desired time to set in the “Other Settings” settings area.

Click ○.

The radial will change to ⊙, and the set auto off time will be selected.

* The example shows None set for the Auto Off function.



Setting

Initial Setting	Setting	Details
●	None	Auto Off will not be performed.
	10 min.	The power will turn OFF automatically if the operation keys are not operated within 10 minutes.
	30 min.	The power will turn OFF automatically if the operation keys are not operated within 30 minutes.
	60 min.	The power will turn OFF automatically if the operation keys are not operated within 60 minutes.

Environment Settings (Changing Instrument Settings) (Cont.)

Date/Time

— Configure as necessary —

Memo This setting is only displayed and usable when the “Save to Instrument” setting for saved data is turned ON using the PC application.

When the PC application is running, the date and time is obtained from the instrument and displayed on the PC application screen.

The PC’s date and time can also be set as the instrument’s date and time.

Memo The time cannot be changed by inputting values on the PC application screen.

1 Go to the “Setting” screen.



2 Select “Get Instrument Date”, and press the \cup button.

The date and time information (yyyy/mm/dd hh:mm:ss) will be obtained from the instrument and reflected in the date (yyyy/mm/dd) and time (hh:mm:ss) displays.
Display format: yyyy/mm/dd
(The date is displayed in year/month/day order.)

3 Select “Set PC Date to Instr.”, and then click \cup .

The date (yyyy/mm/dd) and time (hh:mm:ss) will be obtained from the PC and set to the instrument.
Display format: hh:mm
(The time is displayed in hour:minute order.)

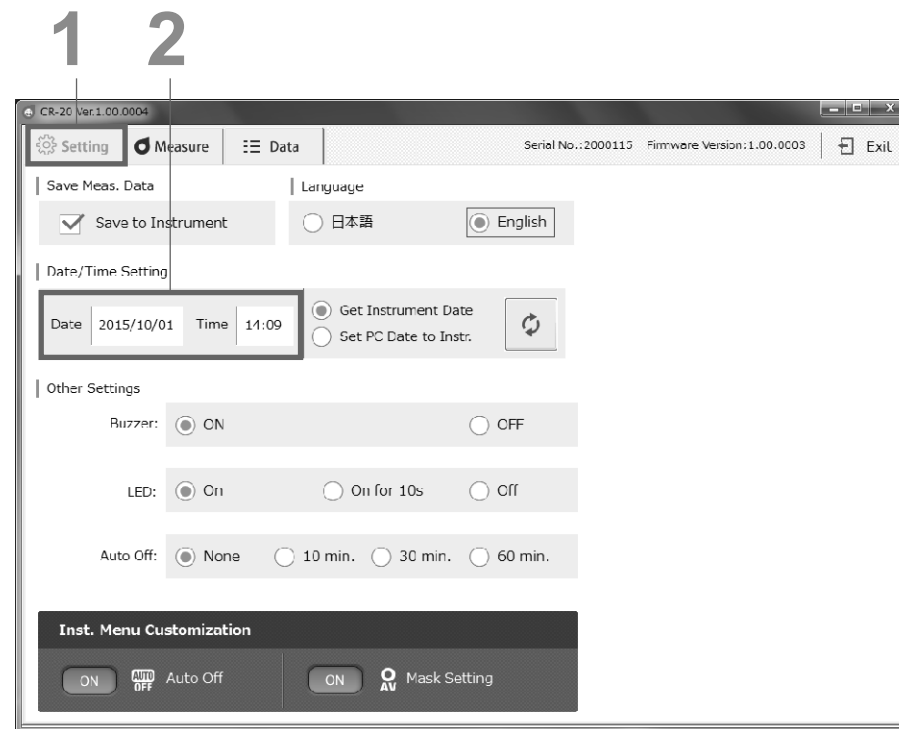

Setting

Year	2000–2099
Month	01–12
Day	01–31
Hour	00–23
Minute	00–59
Second	00–59

Environment Settings (Changing Instrument Settings) (Cont.)

* Settings Only Configurable from the PC Application

— Configure as necessary —

The buzzer is set to “ON” when the instrument is shipped from the factory. This buzzer sound can be switched ON/OFF. Change the settings as required.

Turning the buzzer ON/OFF

The buzzer sound on the instrument can be switched ON/OFF.

Memo Beep (short) When Measuring
 Beep beep When the power is ON
 Beep beep beep When a measurement error occurs

1 Go to the “Setting” screen.



2 Set the buzzer to ON/OFF in the “Other Settings” settings area. Click ○.



Setting

Initial Setting	Setting	Details
•	ON	The buzzer will emit a sound when the power is turned on and when measurement is complete.
	OFF	The buzzer will not emit a sound when the power is turned on or when measurement is complete.

Environment Settings (Changing Instrument Settings) (Cont.)

* Settings Only Configurable from the PC Application

— Configure as necessary —

LED (READY Lamp, STATUS Lamp) Display

The display settings for the LED lamps on the instrument can be changed.

When the LED display is set to ON (either set to “On” or “On for 10s”), the READY lamp will illuminate blue, and the STATUS lamp will illuminate orange.

1 Go to the “Setting” screen.



2 Configure the LED settings under “Other Settings”.

Click ○.

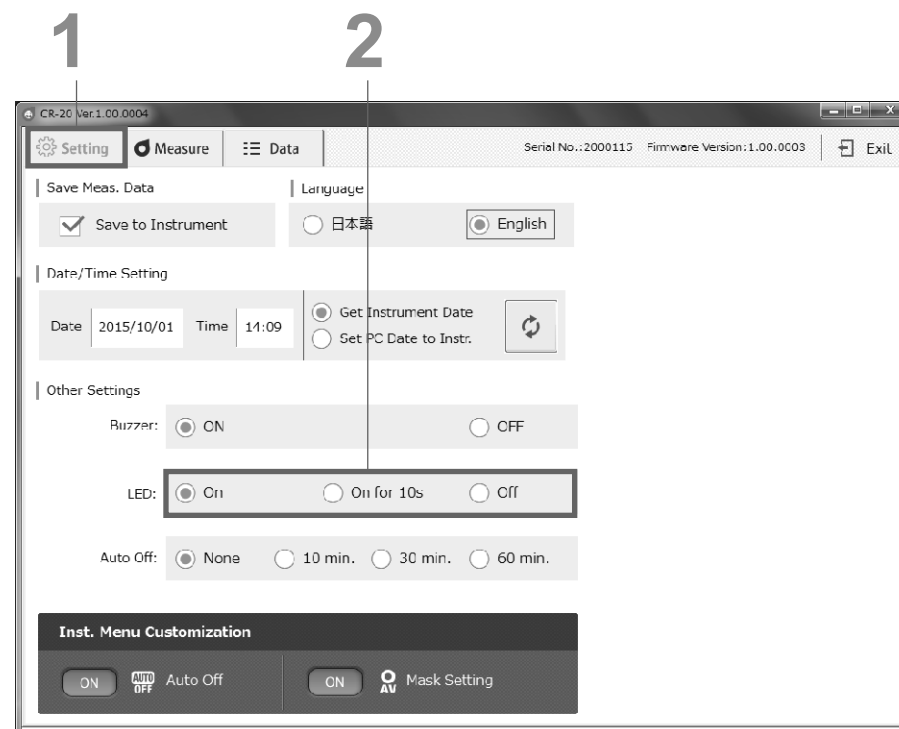

Setting

Initial Setting	Setting	Details
•	On	The LED lamp will be illuminated when the conditions are met.
	On for 10s	The LED lamp will be illuminated for 10 seconds when the conditions are met.
	Off	The LED will not come on even when charging of the light emission circuit is complete after measurement.

Environment Settings (Changing Instrument Settings) (Cont.)

* Settings Only Configurable from the PC Application

— Configure as necessary —

Instrument Menu Customization

This function enables certain settings to be configured on the instrument.

Items switched to ON will be configurable on the instrument.

The items that can be configured on the instrument are as follows.

Memo All settings are set to OFF when shipped from the factory.

1 Go to the “Setting” screen.



2 On the Menu Customization section in the “Setting” screen of the PC application, click the key to the left of the settings you wish to enable to switch them ON/OFF.

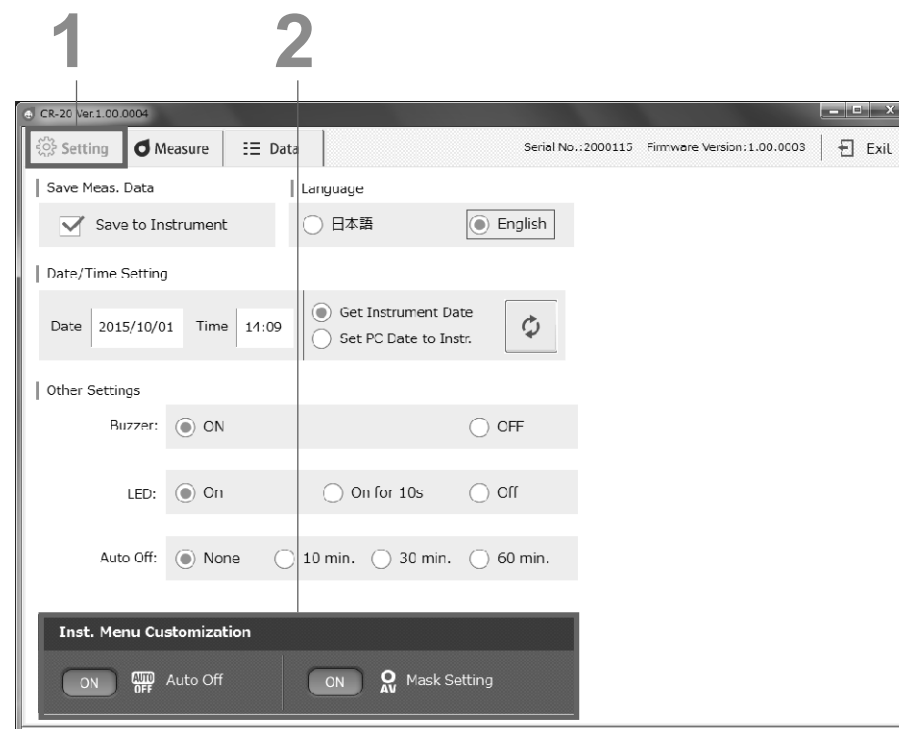

Setting

Auto Off

Mask Setting

PC Application (Measurement)

<Remote Measurement and Trigger Measurement

When the PC application for the instrument is running, measurement can be done remotely or by using a trigger.

■ Remote Measurement

Click the measuring button on the PC application to measure remotely.

■ Trigger Measurement

When the PC application is running, press the measuring button on the instrument to perform measurement.

* Check the box for “Use Measure Button on Inst.”

Notes When trigger measurement has been configured, it is not possible to change tabs or measurement conditions.

White Calibration

This instrument requires white calibration before performing measurement after the power is turned ON. After turning the power ON, if the instrument is immediately connected to the PC without performing white calibration, the PC application will enter white calibration measurement mode. Perform white calibration before beginning measurement.

Memo • Changes in ambient temperature and heat generated from repetitive use may cause subtle deviations in the indicated values. In such cases, perform white calibration regularly.

Notes • **Perform white calibration under the same temperature conditions as when performing measurement.**
• **Perform white calibration after the instrument has had time to adapt to the ambient temperature.**

1 Place the instrument on the white calibration cap.

Memo See page 16 for how to attach the white calibration cap.

2 In the PC application's [Setting] tab, click "White Cal."



Memo At this time, "Use Measure Button on Inst." will be disabled and white calibration from the instrument will not be possible.

3 White calibration will be performed, and the measurement screen will be displayed.

Remove the white calibration cap.

Memo See page 15 for how to remove the cap. Perform measurement to continue.

When a calibration error occurs, the buzzer will beep three times on the third try, and "Calibration Error" will be displayed. Click the MENU/OK button, check that the white calibration cap is correctly attached, and perform white calibration again.

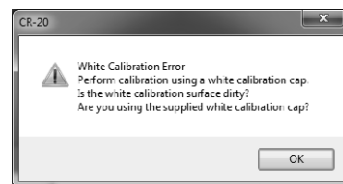

<When a calibration error occurs>

4 Remove the instrument from the white calibration cap.

Memo Put the dedicated lid on the white calibration cap when storing.

5 Perform measurement to continue.

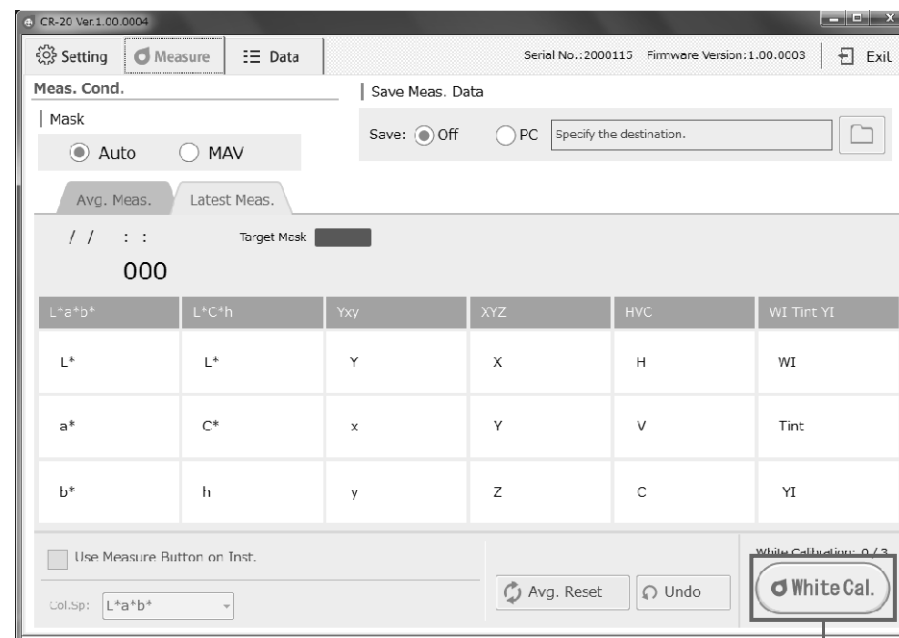

2



Measurement

Measurement

Notes Make sure to perform white calibration before measuring. For details, refer to “White Calibration” on page 27.

- For accurate measurements, measure under the same conditions (ambient temperature, etc.).

1 Press the [Measure] tab to open the measurement screen.

2 Set the sample surface aperture on the sample to measure.

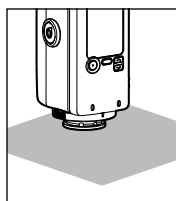

3 A [When measuring remotely]

a-1 Click “Measure” on the PC application.



The measurement results will be displayed in the [Latest Meas.] tab on the PC application.

B [When measuring using a trigger]

b-1 Check the box for “Use Measure Button on Inst.”

b-2 Press the measurement button on the instrument.



The measurement results will be displayed on the instrument and in the [Latest Meas.] tab on the PC application.

Continuously perform measurement in the same way to measure consecutively. To perform the most recent measurement again, click the “Undo” key.

CR-20 Ver.1.00.0004

Serial No.:2000115 Firmware Version:1.00.0003

Meas. Cond. | Save Meas. Data

Mask | Save: Off PC Specify the destination.

Auto MAV

Avg. Meas. | Latest Meas.

Target Mask: [REDACTED]

000

L*a*b*	L*C*h	Yxy	XYZ	HVC	WI Tint YI
L*	L*	Y	X	H	WI
a*	C*	x	Y	V	Tint
b*	h	y	Z	C	YI

Use Measure Button on Inst.

Col.Sp: L*a*b*

Avg. Reset Undo Measure

b-1 **1** **a-1**

001

L*a*b*	L*C*h	Yxy	XYZ	HVC	WI Tint YI
L* 74.7	L* 74.7	Y 47.8	X 45.4	H 1.9Y	WI 33.2
a* 0.4	C* 2.7	x 0.3201	Y 47.8	v 7.3	Tint -2.0
b* 2.6	h 81.9	y 0.3366	z 48.7	c 0.5	YI 6.5

Use Measure Button on Inst.

Col.Sp: L*a*b*

Avg. Reset Undo Measure

Measurement (Cont.)

Avg. Meas.

Using the average measurement function when measuring makes it possible to obtain data that is even more accurate.

If the sample color is uneven, the accuracy of the measurement can be improved by randomly measuring locations within the sample area to calculate the average for the sample, or by repeatedly measuring the same sample location to calculate the average for that location.

Notes After an average is determined for the instrument, because the average is converted for each color space and displayed, the simple averages for measurements of each count may not match.

1 Measure repeatedly until the desired measurement count is reached.

Memo To perform the measurement again during average measurement, click “Undo”.

2 Switch from the [Latest Meas.] tab to the [Avg. Meas.] tab.

The statistical calculation results for measurements up to the number of measurements performed will be displayed.

3 Reset the average.

Click “Avg. Reset”.

Continuing with measurement will switch the display to the [Latest Meas.] tab and the measurement results will be displayed.

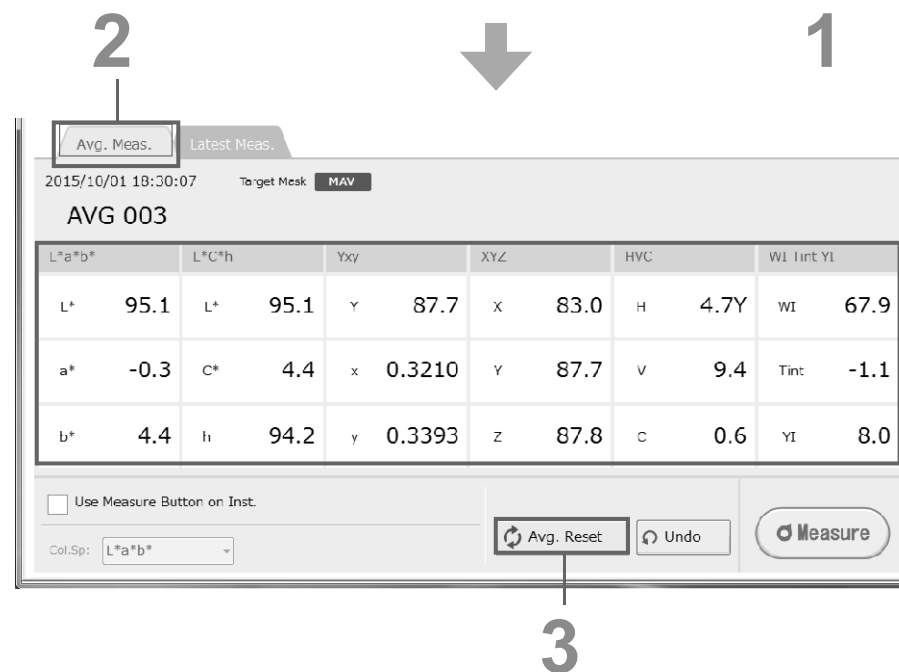
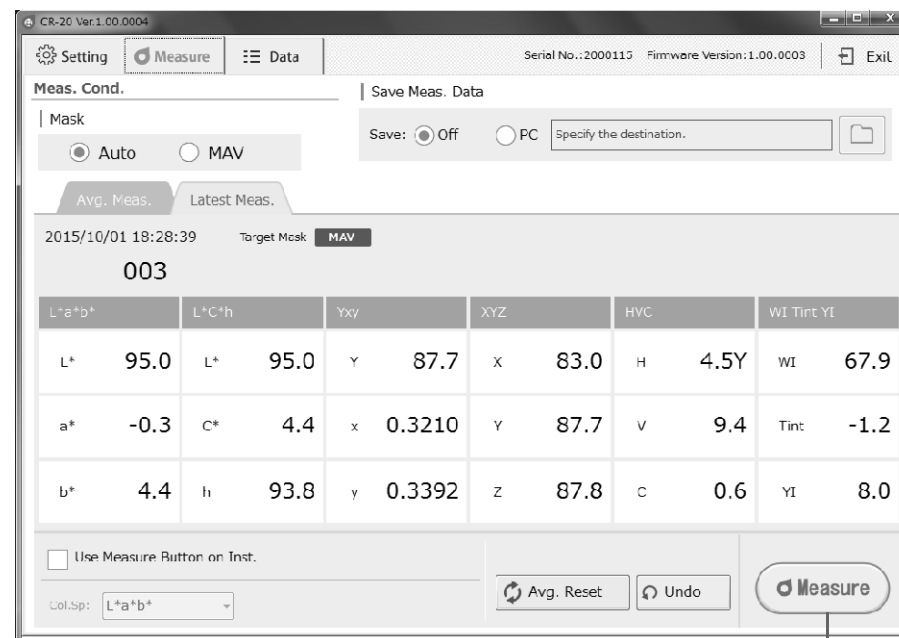

Save Meas. Data

Save Meas. Data

Data measured using remote measurement or trigger measurement through the PC application can be saved to the PC.

Notes For this setting, make sure to copy the PC application to the PC's hard drive before running the application.

1 Under “Save Meas. Data” in the [Measure] tab, click to the left of PC. The “Browse For Folder” window will appear.

2 Select the save destination and Click [OK].
Measurements performed remotely or using triggers will be collected and saved as a .csv file in the folder specified as the save destination.
Save destination folder: Specified folder – “Serial No” folder
— yyyyymmdd (measurement date) folder
File name: numbered according to measurement order
Example: 132648.csv (measurement h:mm:ss)

Memo To change the save destination, click the mark to open the “Browse For Folder” window.

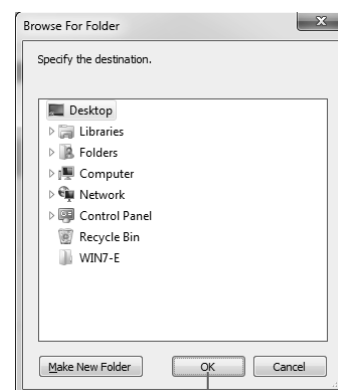
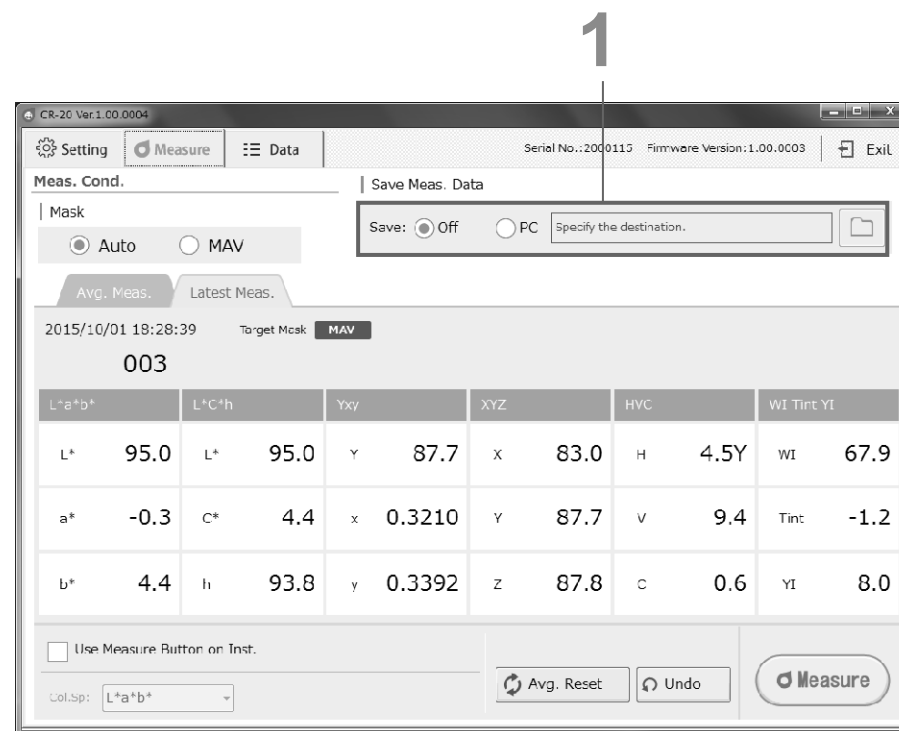

Measurement Result Display

Importing Measurement Data

All data saved in the instrument is referenced and displayed in a list.

Memo This operation is only possible when the “Save to Instrument” setting is turned ON in the PC application and there is saved data in the instrument.

Notes Data acquisition may take longer when the number of data entries is large. Perform this operation when time permits.

1 In the [Data] tab, click “Read”.
Once the data has been transferred to the PC application, a window with the message “Data transfer complete.” will be displayed.

2 Click [OK] to confirm.
Imported data will be displayed in the Target List and the Meas. Result List according to the date and time of measurement.

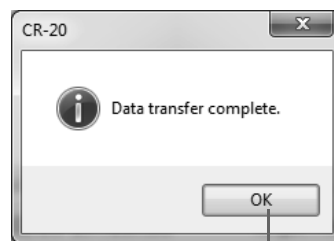

2

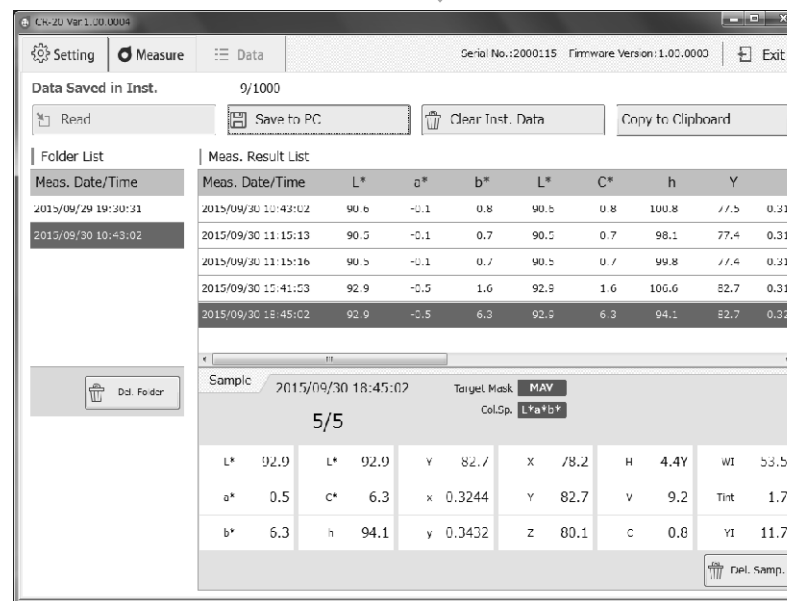
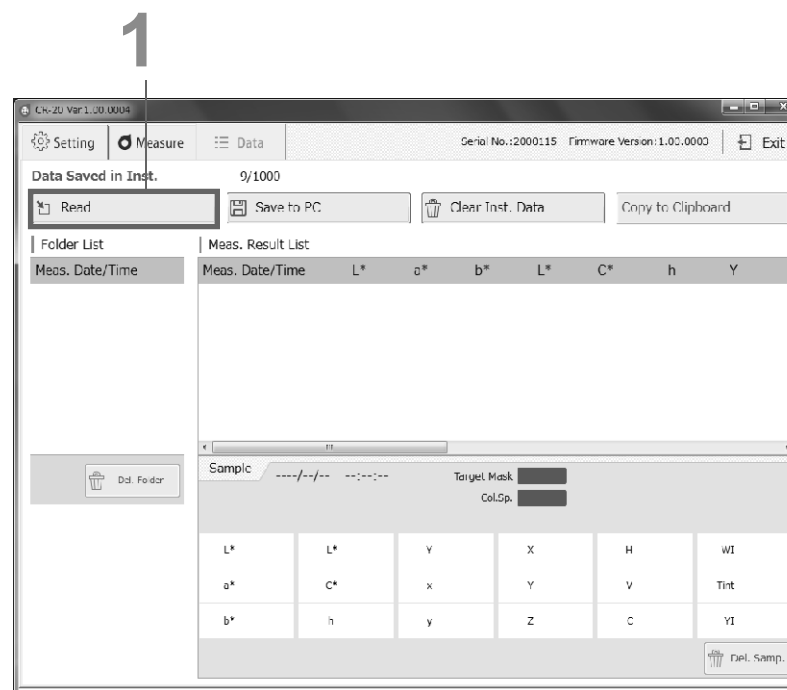

Measurement Data Operations

Save to PC (Obtain Measurement Data Saved in Instrument)

Import data saved in the instrument to a specified destination.

Notes For this setting, make sure to copy the PC application to the PC's hard drive before running the application.

1 Click "Save to PC".

2 In the "Browse For Folder" window, click the save location for the data to select it, and click "OK".

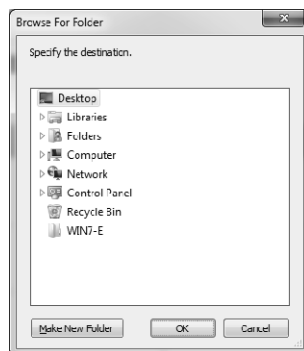

3 The data will be saved.

Also note that data saved to the instrument can be copied directly from within the instrument's mass storage folder.

Memo Exit the PC application if it is running.

1. Connect the instrument to a PC. An AutoPlay dialog will be displayed. Click "Open folder to view file."
2. Click the DATA folder. Folders for each measurement date are created, and measurement data (*****.csv) are saved within. Select the required data, and copy to the PC.

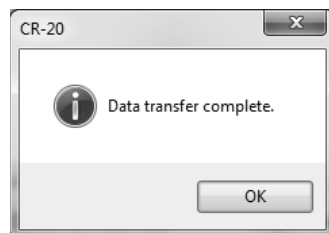

1

Meas. Date/Time	I*	a*	h*	I*	C*	h	Y
2015/09/30 10:43:02	90.6	-0.1	0.8	90.6	0.8	100.8	77.5
2015/09/30 11:15:13	90.5	-0.1	0.7	90.5	0.7	98.1	77.4
2015/09/30 11:15:16	90.5	-0.1	0.7	90.5	0.7	99.8	77.4
2015/09/30 15:41:53	92.9	-0.5	1.6	92.9	1.6	106.6	82.7
2015/09/30 18:45:02	92.9	-0.5	6.3	92.9	6.3	94.1	82.7

Sample	2015/09/30 18:45:02	Target Mask	MAV
5/5			
L*	92.0	L*	92.0
a*	-0.5	c*	6.3
b*	6.3	h	94.1
		y	0.3432
		x	0.3244
		Y	82.7
		v	9.2
		z	80.1
		w	4.4Y
		WI	53.5
		Tint	-1.7
		Y1	11.7

Measurement Data Operations (Cont.)

Clear Inst. Data

Delete all data saved in the instrument. Performing this operation will clear the list.

Memo Data cannot be cleared using the instrument itself.

1 Click "Clear Inst. Data".

2 Click "Yes".

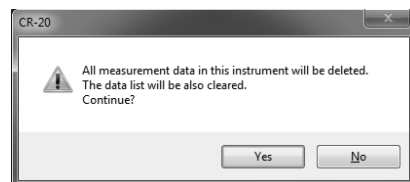

3 The data will be cleared.

4 Click "OK".

Notes When selecting "Clear Inst. Data", data that has been imported and displayed on the PC application using "Read" will be cleared at the same time.

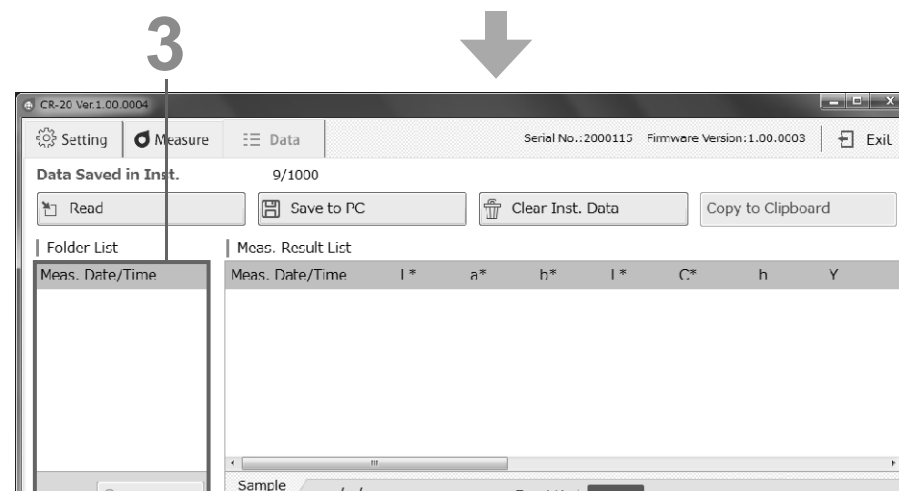
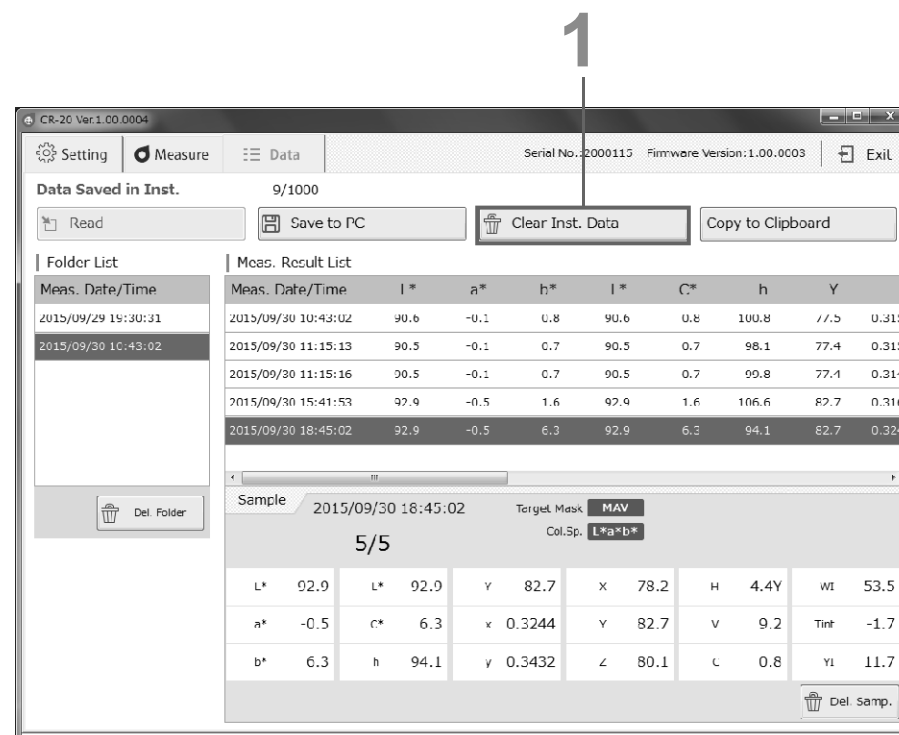

Measurement Data Operations (Cont.)

Copy to Clipboard

Copies all measurement data (data displayed in the measurement results list) within the folder selected in the folder list to the clipboard.

1

Click “Copy to Clipboard”.

Memo

All measurement data for the measurement date and time selected in the folder list will be copied.

Copied data can be pasted into Excel and other applications.

The screenshot shows the CR-20 software interface. At the top, there are tabs for 'Setting', 'Measure', and 'Data'. The 'Data' tab is active, showing 'Data Saved in Inst.' as 9/1000. Below this are buttons for 'Read', 'Save to PC', 'Clear Inst. Data', and 'Copy to Clipboard'. The 'Copy to Clipboard' button is highlighted with a red box and a red arrow labeled '1'. The main area is divided into two sections: 'Folder List' and 'Meas. Result List'. The 'Folder List' shows a table with 'Meas. Date/Time' entries. The 'Meas. Result List' shows a table with columns for 'Meas. Date/Time', 'I*', 'a*', 'h*', 'I*', 'C*', 'h', and 'Y'. Below these tables is a 'Sample' section showing 'Sample 2015/09/30 18:45:02' and '5/5'. The 'Sample' section also includes 'Target Mask' (MAV) and 'Col.Sp.' (L*a*b*). At the bottom right, there is a 'Del. Samp.' button.

Meas. Date/Time	I*	a*	h*	I*	C*	h	Y
2015/09/29 19:30:31	90.6	-0.1	0.8	90.6	0.8	100.8	77.5 0.312
2015/09/30 10:43:02	90.5	-0.1	0.7	90.5	0.7	98.1	77.4 0.312
2015/09/30 11:15:13	90.5	-0.1	0.7	90.5	0.7	99.8	77.4 0.312
2015/09/30 11:15:16	90.5	-0.1	0.7	90.5	0.7	99.8	77.4 0.312
2015/09/30 15:41:53	92.9	-0.5	1.6	92.9	1.6	106.6	82.7 0.312
2015/09/30 18:45:02	92.9	-0.5	6.3	92.9	6.3	94.1	82.7 0.324

Sample	2015/09/30 18:45:02	Target Mask	MAV
5/5		Col.Sp.	L*a*b*
L*	92.9	L*	92.9
a*	-0.5	c*	6.3
b*	6.3	h	94.1
Y	82.7	x	78.2
X	78.2	Y	82.7
H	4.4Y	V	9.2
WI	53.5	Tin†	-1.7
		YI	11.7

Chapter 4

Other Functions

Connecting a Printer

Connecting a Printer

The instrument can be connected to the accessory printer so that the data displayed on the instrument's LCD screen can be printed. For information on connectable printers, contact a KONICA MINOLTA-authorized service facility.

- Memo**
- Only text can be output to the printer.
 - The USB communication port on the instrument is USB 2.0-compliant.

- Notes**
- **Firmly push in the USB cable connector that matches the shape of the port (connection terminal) until it can go in no further.**
 - **Make sure the power to both the instrument and the printer is turned OFF before connecting or disconnecting.**
 - **Disconnect the connection cord only by the plug or by holding the connector. Also, do not pull the cord itself or bend it with unreasonable force.**
 - **Do not touch the terminal portion of the connector, get the terminals wet, or subject the terminals to unreasonable force.**
 - **Use a cord with a suitable length. If the cable is not of a suitable length, connection problems may arise or the cable may break.**
 - **The instrument has one USB connection terminal. Connecting to both a PC and a printer at the same time is not possible. When connected to a printer, make sure the instrument is connected to the AC adapter or has batteries.**

Operating Procedure

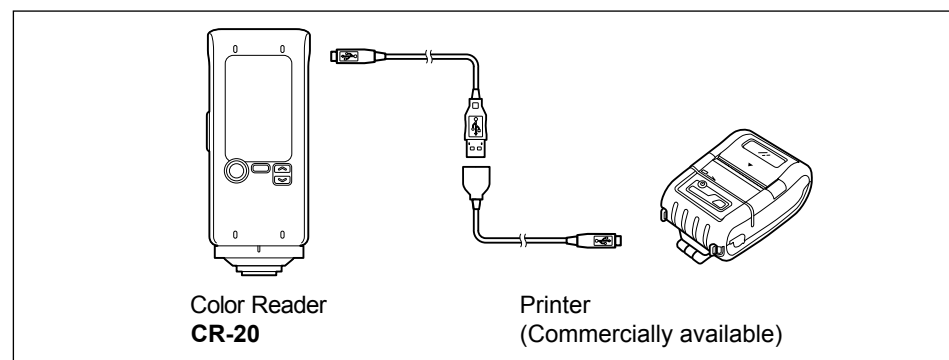

- 1 **Turn the instrument power OFF.**
Open the connector's protective cover, and connect the USB cable to the USB port on the instrument. Connect the Micro-A connector of the USB cable to the USB connection terminal on the instrument.
◆ **Firmly push it in until it can go no further and verify that it is securely connected.**
- 2 **Connect the Micro-B connector of the USB cable to the USB port on the printer.**
- 3 **Turn the instrument power ON.**
- 4 **Turn the printer ON.**
- 5 Press on the instrument, move the selection frame to "USB Connec." using either or , and then press .
- 6 Move the selection frame to "Printer" using either or , and then press .
- 7 Click "Back" to go back to the <MENU> screen.

Memo When connected to a printer, the instrument will display the printer connection icon () on the top of the LCD screen.

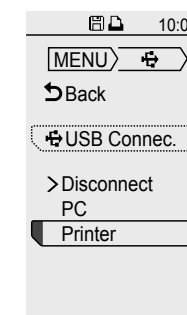
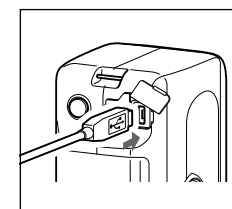

Connecting a Printer (Cont.)

Printing Measurement Data

This function can be used to print measurement data.

The instrument must be connected to the printer in advance. See page 65 “Connecting a Printer” for details on connecting the instrument to a printer.

Notes Printing is not possible if the connection is not correct.

- Do not disconnect the cable while printing. Failure to do so may cause a malfunction.

Setting Procedure

- Connect the instrument to the printer and enable communication.
- Press \odot “Back” from the <MENU> screen to go to the measurement screen.
- Perform measurement.
- The measurement results will be displayed on the instrument's LCD screen and at the same time the printer will begin printing.

Disconnecting from the Printer

- Disconnect the printer from the instrument.
- Press \odot MENU/OK, move the selection frame to “USB Connec.” using either \uparrow or \downarrow , and then press \odot MENU/OK.

- Move the selection frame to “Disconnect” using either \uparrow or \downarrow , and then press \odot MENU/OK.

Notes To print again, turn the printer OFF once, and reconnect the printer from the first step.

- Click \odot “Back” to go back to the <MENU> screen.

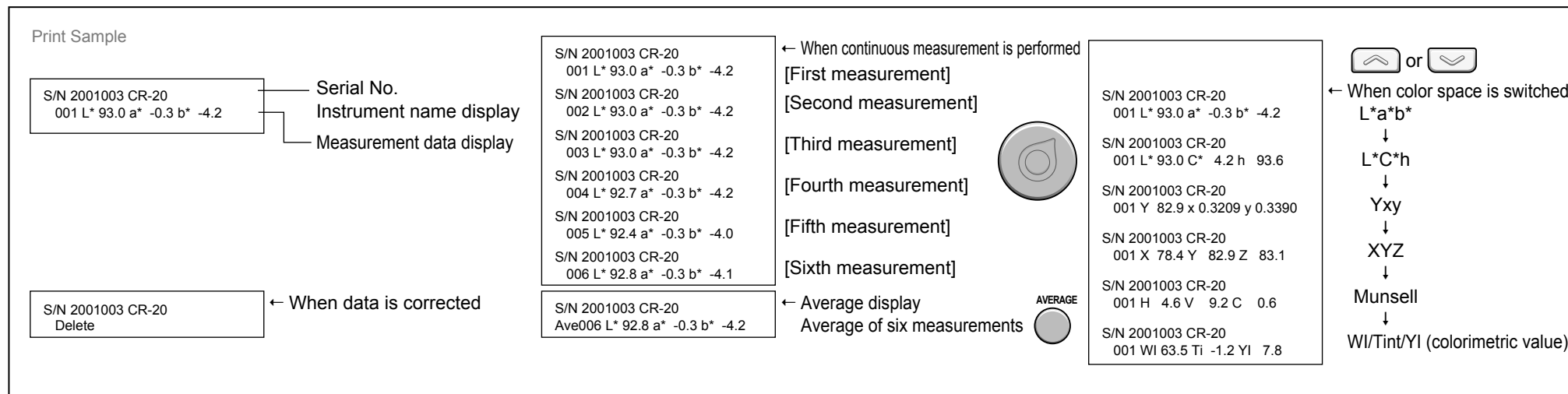

Chapter 5

Troubleshooting

Memory Errors

The following may occur if the cable connecting the instrument to the PC is disconnected.

- It may become impossible to save files to the instrument.
- Files saved on the instrument may become unreadable.

Data recovery can be performed if such memory errors occur.

Notes After a memory error occurs, the data will be recovered. Although measurement is possible, the measurement data cannot be saved to the instrument.

Recover may take several minutes. During the recovery process, all operations will be prohibited.

When not performing recovery

Notes Only measurement will be possible if recovery is not performed. When an error occurs, measurement data cannot be saved even if “Save to Instrument” is set. An error message will be displayed every time the power is turned on until system recovery is performed.

1 Select “No” and confirm.

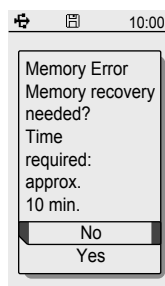

2 Review the message and press “OK” to confirm.



The display will return to the measurement screen.

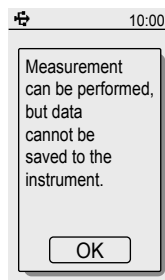

Performing Recovery

1 Select “Yes” and confirm.

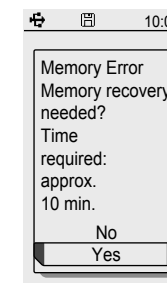

2 Review the message and press “OK” to confirm.



The power will turn OFF automatically.

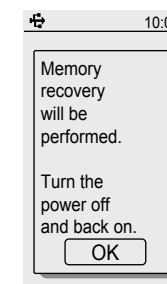

3 Press again to turn the power ON.

A message is displayed after the power is turned on.

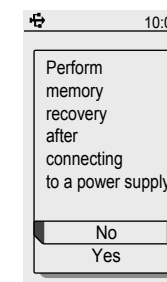

Memory Errors (Cont.)

4 Check whether the USB cable is connected or if there is sufficient battery power remaining.

5 Select “Yes” and confirm.



Notes System recovery will not be possible if the power supply is turned off during recovery. Make sure the cable is connected to USB bus power or the AC adapter as the power source.

Memo Recovery will not be performed if “No” is selected. A message that reads, “Measurement can be performed, but data cannot be saved to the instrument.” will be displayed. Press the MENU/OK key to confirm the message.

6 “Recovering memory.” will be displayed, and the recovery process will begin (required time: approx. 10 minutes).

Once memory recovery is complete, one of the following messages noting success or failure will be displayed.

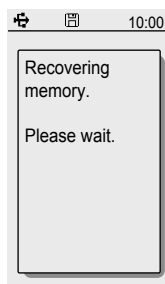

<Memory recovery successful>

7 Click “OK”.



A screen prompting white calibration will be displayed.

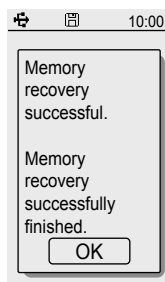

<Memory recovery failed>

Click “OK”.

Notes If this message is displayed, contact a KONICA MINOLTA-authorized service facility.

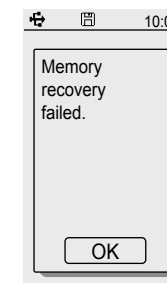

Error Messages

The messages below may be displayed when using the instrument. When one of these messages is displayed, please take the action indicated below. After performing the action, if the instrument does not return to normal, contact a KONICA MINOLTA-authorized service facility.

Error Messages		Condition / Assumed Factor	Action
Instrument	PC application		
Measurement Error: Output not reaching min threshold? The sample is too dark.	The sample's reflectance is below the measure limit.	This message is displayed if the sample's reflectance is low or if the amount of light from the sample is too low.	Samples with too low of a reflectance ($L^* < 1.0$) cannot be measured.
Measurement Error: Retention? Measure again.	Instrument retention is unstable? Secure the mask by pressing it against the measured object, and perform measurement again.	This message is displayed when measurement was not performed correctly, such as when external light enters the measurement area during measurement.	Perform measurement again while making sure not to move the instrument until the measurement results are displayed.
Measurement Error Turn the power off and back on.	Control Error: Turn the power off and back on.	The circuit is faulty. <ul style="list-style-type: none"> • Charging circuit • A/D conversion circuit • Measurement circuit 	Turn instrument off and back on. If the situation does not improve, contact a KONICA MINOLTA-authorized service facility.
Measurement Error: Flash Service is required.	Measurement Error: Flash No flash is being emitted. Service is required.	The xenon tube is burnt out.	Contact a KONICA MINOLTA-authorized service facility.
Target Mask Detection Error Correctly attach a target mask.	No target mask found. Attach a target mask.	Attachment of a target mask cannot be detected. <ul style="list-style-type: none"> • No target mask is attached. • The target mask is not attached in the correct fixed position. 	When measuring, be sure to attach a target mask. Refer to page 15 for how to correctly attach the target mask.
Calibration Error Please re-calibrate.	White Calibration Error Perform calibration using the white calibration cap. Is the white calibration surface dirty? Are you using the supplied white calibration cap?	White calibration was not performed in the correct procedure.	Use the white calibration cap included with the instrument. Before beginning, make sure the white calibration area is not dirty. When calibrating, make sure the sample surface aperture and the white calibration area are close together. If the situation does not improve, contact a KONICA MINOLTA-authorized service facility.
Low Battery Replace the battery.		(When using the instrument on battery power) <ul style="list-style-type: none"> • Batteries are low on power. 	Insert new batteries, or use the AC adapter.
Printers cannot be connected when the unit is powered via USB. Use the AC adapter or batteries.		Because switching to the printer connection setting when the instrument is powered by a PC or the USB-AC adapter will cause the power supply to be stopped, which may damage the memory, this setting cannot be changed.	When connecting the instrument to a printer, make sure to connect the instrument to the printer using a USB cable, and make sure the instrument is being powered through the AC adapter or by batteries.
The memory is full. Delete unnecessary data.	The memory is full. To gain measurement memory space, please delete any unnecessary measurement data.	Even if the setting for saving measurement data to the instrument is set to ON, data cannot be saved because the number of saved data entries will exceed 1000 entries upon the next measurement.	Use the PC application to delete unnecessary data saved to the instrument. Refer to page 62 for the operating procedure.
Memory Error Recover memory? Time required: approx. 10 min.	Memory Error Perform memory recovery? The process will take about 10 minutes. Do not turn the power off during that time.	Some data saved in the instrument may be corrupt, which is preventing the data from being accessed properly.	Refer to page 68 for details. If the situation does not improve, contact a KONICA MINOLTA-authorized service facility.
Date and Time Setting Error Please re-set the time.		This message is displayed if the instrument has not been connected to the power source for a long period of time and the backup battery has died, causing the built-in clock to stop.	After setting the time, leave the instrument connected to a power source in order to charge the backup battery. (Charging will be performed even if the instrument is OFF.) Refer to page 4 for details.

Checking for Malfunction

In the event that of a malfunction with the instrument, carry out the following measures.

If the instrument does not return to normal, try turning the power OFF. If this does not work, contact the nearest KONICA MINOLTA-authorized service facility.

	Condition	Cause	Action
1	No display appears on the LCD screen.	Are batteries inserted? Alternatively, is the AC adapter connected?	Insert batteries. Alternatively, use the AC adapter.
		Are the batteries dead?	Replace the batteries.
		Are the batteries inserted with the correct orientation?	Insert the batteries with the correct orientation.
2	Measuring button operations are not being accepted.	Is the light source for measurement (pulse xenon lamp) charging?	After charging completes, make sure the READY lamp is illuminating, and then push the button.
		Is the settings screen displayed?	Click the button from the measurement screen.
3	Key operations are not being accepted.	Is the instrument connected to the PC application?	When connected to the PC application, only MENU/OK key operations and power button operations will be recognized. Finish connecting to the PC application.
4	Connection to the PC application cannot be established.	Is "Connecting to PC" displayed for the USB setting on the instrument?	Turn the instrument on, and select "PC" under "USB Connec." on the settings screen to allow the instrument to be connected to the PC.
		Are the instrument and the PC connected using a USB cable for connecting to a PC?	Connect the instrument to the PC using the USB cable supplied with the instrument.
		Are 2 or more instruments connected to the PC?	The PC application supplied with the CR-20 can only be used when connected to one instrument. Connect only 1 instrument to the PC.
5	The LEDs do not illuminate.	Is the LED setting set to "Off"?	Connect to the PC application and check the settings.
6	The buzzer does not sound.	Is the buzzer setting set to "Off"?	Connect to the PC application and check the settings.
7	Printing is not possible.	Is "Printer" displayed for the USB setting on the instrument?	Turn the instrument on, and select "Printer" under "USB Connec." on the settings screen to allow the instrument to be connected to the printer.
		Are the instrument and the printer connected using the USB cable for the printer?	Connect the instrument to the printer using the USB cable supplied with the printer.
		Is the printer turned ON?	Turn on the printer before connecting to the instrument.
		Was the USB cable disconnected once while connection to the printer was being established and then reconnected?	If the USB cable was disconnected while the connection was being established, communication between the instrument and the printer may not function properly. Turn the printer OFF once, and reconnect the printer from the first step.
8	Measurement results are not normal.	Is the instrument perpendicular to the measurement sample surface?	When measuring, make sure the instrument is perpendicular to the surface so that no light escapes.
		Was the instrument moved during measurement?	Do not move the instrument when measuring.
		Are the temperature and humidity of the measurement environment appropriate?	Be sure to use the instrument within the operating temperature and humidity range.

Chapter 6

Appendix

Dimensions

(Unit: mm)

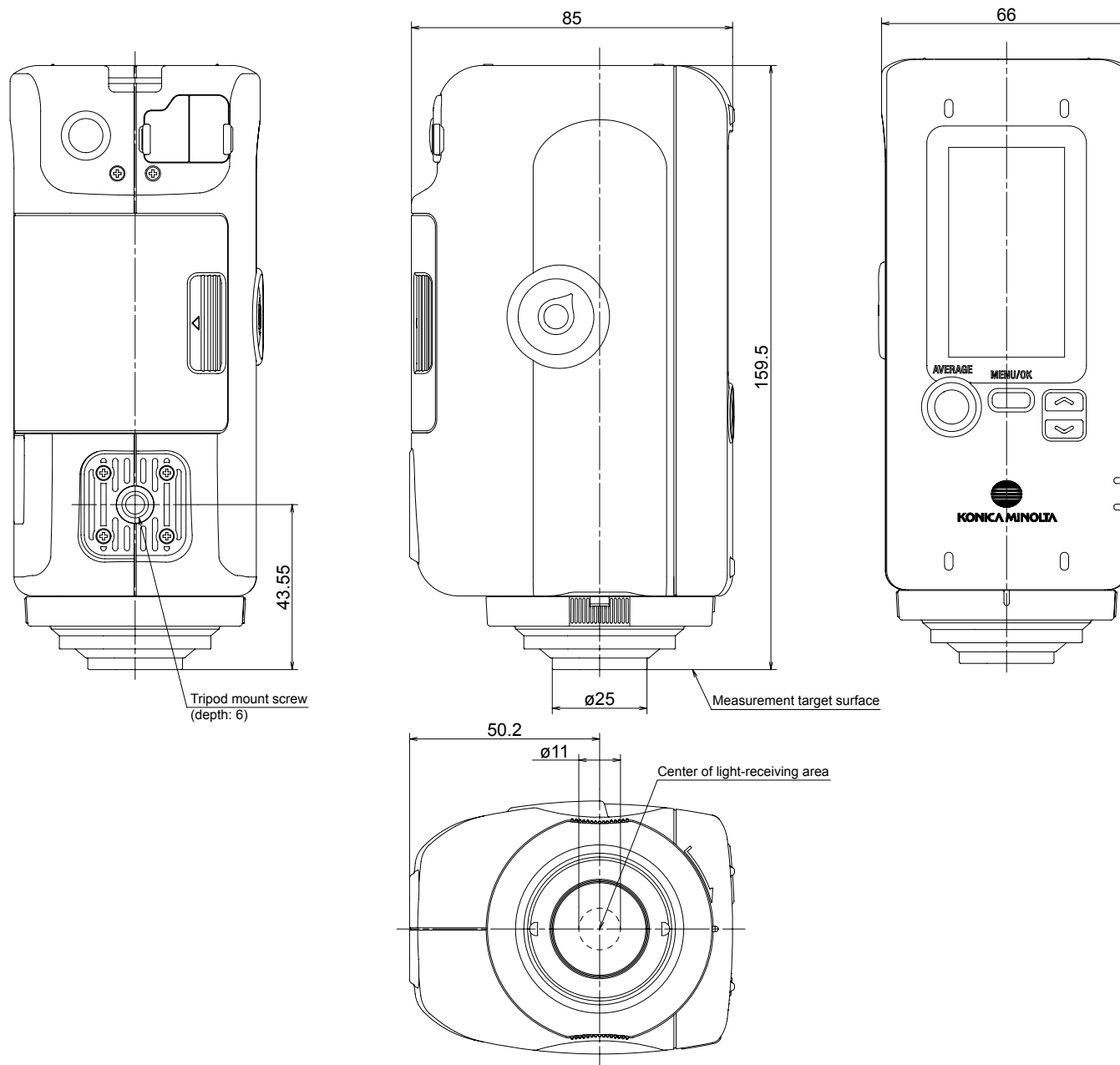

Main Specifications

Model	Color Reader CR-20
Illumination/viewing system	8° : de (8° illumination angle/diffuse viewing: specular component excluded) (conforms to DIN 5033 Teil 7, JIS Z 8722 condition d, ISO 7724/1, CIE No. 15, ASTM E 1164)
Detector	Silicon photocells (6 pcs.)
Light source	Pulsed xenon lamps
Measurement time	Approx. 1 sec.
Battery performance	Approx. 2,000 measurement at 10-sec. intervals when using alkaline-manganese batteries
Measurement area	Approx. ø8 mm
Repeatability	Standard deviation within ΔE^*ab 0.1 (when a white calibration plate is measured 30 times at 10-second intervals)
Display languages	English, Japanese
Interface	USB 2.0
Observer	10° Standard Observer
Illuminant	D65
Displayed data	Colorimetric data, average (up to 999 times)
Color spaces	L*a*b*, L*C*h, Yxy, XYZ, Munsell(D65)
Colorimetric indexes	WI (CIE/ASTM E 313-96), Tint (CIE/ASTM E 313-96), YI (ASTM E 313-96)
Data memory	Sample data (up to 1,000)
Operation temperature/humidity range	0 to 40°C, relative humidity 85% or less (at 35°C) with no condensation
Storage temperature/humidity range	-20 to 40°C, relative humidity 85% or less (at 35°C) with no condensation
Power	4 AA-size alkaline dry batteries or nickel-metal-hydride rechargeable batteries, USB bus power or special AC Adapter
Size (W x H x D)	66 x 159.5 x 85 mm
Weight	420 g (without batteries)

PC System Requirements

- **OS**
Windows 7 Professional 32bit, 64bit
Windows 8 Pro 32bit, 64bit
Windows 8 .1 Pro 32bit, 64bit
(English or Japanese)
- **The hardware of the computer system to be used must meet or exceed the recommended system requirements for compatible OS being used.**
- **One USB2.0 port is necessary.**

< CAUTION >

KONICA MINOLTA WILL NOT BE LIABLE FOR ANY DAMAGES RESULTING FROM THE MISUSE, MISHANDLING, UNAUTHORIZED MODIFICATION, ETC. OF THIS PRODUCT, OR FOR ANY INDIRECT OR INCIDENTAL DAMAGES (INCLUDING BUT NOT LIMITED TO LOSS OF BUSINESS PROFITS, INTERRUPTION OF BUSINESS, ETC.) DUE TO THE USE OF OR INABILITY TO USE THIS PRODUCT.



KONICA MINOLTA